

Florian light



LightCollection 2014

Listino - Price List



Florian light

FLORIAN GABRIELE
VIA TINTORETTO, 16/b
31056 RONCADE
(TREVISO) - ITALIA
+39 0422 840537
info@florianlight.com
www.florianlight.com

ALOHA

Lampada con montaggio a luce indiretta. Diffusore e rosone in vetro ceramico bianco. Particolari laterali in vetro float. Struttura in metallo.

Lamp with direct light. Glass diffuser and cover in white ceramic glass. Float glass side details. Metal structure.

ALOHA SOSPENSIONE/HANGING LAMP

CODICE/CODE

€

€+IVA

LAMPADINA/BULB

INFO

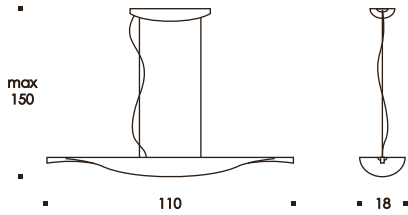

T1.002 BIANCO
WHITE

627,00

764,94

R7s 80mm
MAX 2x150W

R7s 80mm
energy saving
MAX 2x100W



PESO/WEIGHT
5,5 kg
12,13 lbs

IMBALLO/BOX (cm)
120x27x25

VOLUME/VOLUME
0,081 m³

CLASSE ENERGETICA
ENERGY EFFICIENCY CLASS
C , D

ALIMENTAZIONE
POWER SUPPLY
230V 50/60Hz

ALOHA PARETE / WALL LAMP

CODICE/CODE

€

€+IVA

LAMPADINA/BULB

INFO

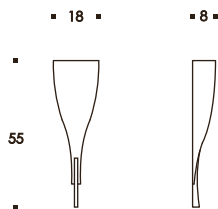

T3.023 BIANCO
WHITE

294,00

358,68

E14 MAX 1x60W

E14 energy saving
MAX 1x11W

E14 LED MAX 1x4,5W



PESO/WEIGHT
2,0 kg
4,41 lbs

IMBALLO/BOX (cm)
66x27x17

VOLUME/VOLUME
0,030 m³

CLASSE ENERGETICA
ENERGY EFFICIENCY CLASS
A+ - E

ALIMENTAZIONE
POWER SUPPLY
230V 50/60Hz

ARC

Lampada a luce diretta, con sorgente luminosa in vetro temperato con satinatura.
Struttura in metallo con finitura cromo perlato.
Tecnologia a led.

Lamp with direct light, with the light source in tempered glass with satin finish.
Metal frame with chrome finish pearl.
LED technology.

ARC SOSPENSIONE/HANGING LAMP

	CODICE/CODE	€	€+IVA	LAMPADINA/BULB	INFO	
	F1.001 VETRO TEMPERATO TEMPERED GLASS	710,00	866,20	 288 LED 34,3W ■ bianco caldo warm white 3000K	CE      	PESO/WEIGHT 4,0 kg 8,82 lbs IMBALLO/BOX (cm) 160x25x11 VOLUME/VOLUME 0,044 m ³ CLASSE ENERGETICA ENERGY EFFICIENCY CLASS A ⁺⁺ - A (LED) ALIMENTAZIONE POWER SUPPLY 110V 50/60Hz 240V 50/60Hz
	dimmerabile/dimmable F1.016 VETRO TEMPERATO TEMPERED GLASS	710,00	866,20			

ARC SMALL PARETE / WALL LAMP

	CODICE/CODE	€	€+IVA	LAMPADINA/BULB	INFO	
	F3.001 VETRO TEMPERATO TEMPERED GLASS	397,00	484,34	 72 LED 5,8W ■ bianco caldo warm white 3000K	CE     	PESO/WEIGHT 2,0 kg 4,41 lbs IMBALLO/BOX (cm) 80x25x11 VOLUME/VOLUME 0,022 m ³ CLASSE ENERGETICA ENERGY EFFICIENCY CLASS A ⁺⁺ - A (LED) ALIMENTAZIONE POWER SUPPLY 110V 50/60Hz 240V 50/60Hz
	dimmerabile/dimmable F3.036 VETRO TEMPERATO TEMPERED GLASS	397,00	484,34			

ARC MAX PARETE / WALL LAMP

	CODICE/CODE	€	€+IVA	LAMPADINA/BULB	INFO	
	F3.002 VETRO TEMPERATO TEMPERED GLASS	565,00	689,30	 276 LED 33,1W ■ bianco caldo warm white 3000K	CE      	PESO/WEIGHT 4,0 kg 8,82 lbs IMBALLO/BOX (cm) 160x25x11 VOLUME/VOLUME 0,044 m ³ CLASSE ENERGETICA ENERGY EFFICIENCY CLASS A ⁺⁺ - A (LED) ALIMENTAZIONE NETZANSCHLUß 110V 50/60Hz 240V 50/60Hz (predisposta per alimentarla tramite spina elettrica) - (Arranged to befed with electric plug)
	dimmerabile/dimmable F3.036 VETRO TEMPERATO TEMPERED GLASS	565,00	689,30			

CIRCLE

Lampada a luce diretta. Costituita da più fonti di luci in vetro, trasparente o satinato. Struttura in metallo con finitura cromo perlato, verniciato bianco lucido o nero lucido. Tecnologia a LED. Fonte di luce brevettato®.

Lamp with fitting that provides direct light. Composed of several lights in clear or satin-finish glass. Structure in metal with pearlescent chrome or gloss painted finish. Patented light source ®.

CIRCLE C3 SOFFITTO-PARETE / CEILING-WALL

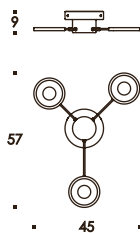

F3.007* CROMO PERLATO PEARLED CHROME

€ 385,00

€+IVA 469,70

48 LED x3 11,5W
 ■ bianco caldo warm white 3000K



PESO/WEIGHT
3,5 kg
7,72 lbs

IMBALLO/BOX (cm)
67x55x16

VOLUME/VOLUME
0,059 m³

CLASSE ENERGETICA ENERGY EFFICIENCY CLASS
A++ - A (LED)

ALIMENTAZIONE POWER SUPPLY
110V 50/60Hz
240V 50/60Hz

F3.008* BIANCO LUCIDO GLOSS WHITE

€ 385,00

€+IVA 469,70

F3.009* NERO LUCIDO GLOSS BLACK

€ 385,00

€+IVA 469,70

xx.xxx /A con vetri trasparenti with transparent glass
xx.xxx /B con vetri satinati with satin glass

* Accostare la lettera per specificare la finitura del vetro. (es. F0.000/A)

* Match the letter to the code to specify the type of glass finish required.(es. F0.000/A)

CIRCLE C4 SOFFITTO-PARETE / CEILING-WALL

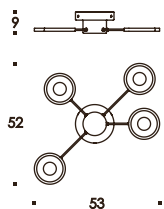

F3.010* CROMO PERLATO PEARLED CHROME

€ 485,00

€+IVA 591,70

48 LED x4 15,4W
 ■ bianco caldo warm white 3000K



PESO/WEIGHT
4,0 kg
8,82 lbs

IMBALLO/BOX (cm)
77x62x16

VOLUME/VOLUME
0,076 m³

CLASSE ENERGETICA ENERGY EFFICIENCY CLASS
A++ - A (LED)

ALIMENTAZIONE POWER SUPPLY
110V 50/60Hz
240V 50/60Hz

F3.011* BIANCO LUCIDO GLOSS WHITE

€ 485,00

€+IVA 591,70

F3.012* NERO LUCIDO GLOSS BLACK

€ 485,00

€+IVA 591,70

xx.xxx /A con vetri trasparenti with transparent glass
xx.xxx /B con vetri satinati with satin glass

* Accostare la lettera per specificare la finitura del vetro. (es. F0.000/A)

* Match the letter to the code to specify the type of glass finish required.(es. F0.000/A)

CIRCLE C6 SOFFITTO-PARETE / CEILING-WALL

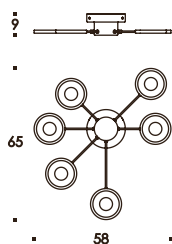

F3.013* CROMO PERLATO PEARLED CHROME

€ 635,00

€+IVA 774,70

48 LED x6 23,0W
 ■ bianco caldo warm white 3000K



PESO/WEIGHT
4,5 kg
9,92 lbs

IMBALLO/BOX (cm)
77x62x16

VOLUME/VOLUME
0,076 m³

CLASSE ENERGETICA ENERGY EFFICIENCY CLASS
A++ - A (LED)

ALIMENTAZIONE POWER SUPPLY
110V 50/60Hz
240V 50/60Hz

F3.014* BIANCO LUCIDO GLOSS WHITE

€ 635,00

€+IVA 774,70

F3.015* NERO LUCIDO GLOSS BLACK

€ 635,00

€+IVA 774,70

xx.xxx /A con vetri trasparenti with transparent glass
xx.xxx /B con vetri satinati with satin glass

* Accostare la lettera per specificare la finitura del vetro. (es. F0.000/A)

* Match the letter to the code to specify the type of glass finish required.(es. F0.000/A)

CIRCLE L3 PARETE / WALL LAMP

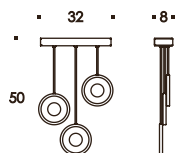

F3.016* CROMO PERLATO PEARLED CHROME

€ 395,00

€+IVA 481,90

48 LED x3 11,5W
 ■ bianco caldo warm white 3000K



PESO/WEIGHT
3,5 kg
7,72 lbs

IMBALLO/BOX (cm)
60x42x15

VOLUME/VOLUME
0,038 m³

CLASSE ENERGETICA ENERGY EFFICIENCY CLASS
A++ - A (LED)

ALIMENTAZIONE POWER SUPPLY
110V 50/60Hz
240V 50/60Hz

F3.017* BIANCO LUCIDO GLOSS WHITE

€ 395,00

€+IVA 481,90

F3.018* NERO LUCIDO GLOSS BLACK

€ 395,00

€+IVA 481,90

xx.xxx /A con vetri trasparenti with transparent glass
xx.xxx /B con vetri satinati with satin glass

* Accostare la lettera per specificare la finitura del vetro. (es. F0.000/A)

* Match the letter to the code to specify the type of glass finish required.(es. F0.000/A)

CIRCLE L5 PARETE / WALL LAMP

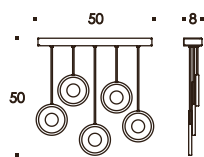

CODICE/CODE

€

€+IVA

LAMPADINA/BULB

INFO

F3.019* CROMO PERLATO
PEARLED CHROME

598,00

729,56

48 LED x5 19,2W
 bianco caldo
warm white
3000K



PESO/WEIGHT
4,8 kg
10,58 lbs

IMBALLO/BOX (cm)
60x60x20

VOLUME/VOLUME
0,072 m³

CLASSE ENERGETICA
ENERGY EFFICIENCY CLASS
A⁺⁺ - A (LED)

ALIMENTAZIONE
POWER SUPPLY
110V 50/60Hz
240V 50/60Hz

XX.XXX /**A** con vetri trasparenti
with transparent glass

XX.XXX /**B** con vetri satinati
with satin glass

* Accostare la lettera per
specificare la finitura del vetro.
(es. F0.000/A)

* Match the letter to the code to
specify the type of glass finish
required.(es. F0.000/A)

CIRCLE L9 PARETE / WALL LAMP

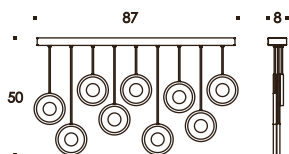

CODICE/CODE

€

€+IVA

LAMPADINA/BULB

INFO

F3.022* CROMO PERLATO
PEARLED CHROME

1.050,00

1.281,00

48 LED x9 34,6W
 bianco caldo
warm white
3000K



PESO/WEIGHT
7,2 kg
15,87 lbs

IMBALLO/BOX (cm)
100x60x15

VOLUME/VOLUME
0,090 m³

CLASSE ENERGETICA
ENERGY EFFICIENCY CLASS
A⁺⁺ - A (LED)

ALIMENTAZIONE
POWER SUPPLY
110V 50/60Hz
240V 50/60Hz

XX.XXX /**A** con vetri trasparenti
with transparent glass

XX.XXX /**B** con vetri satinati
with satin glass

* Accostare la lettera per
specificare la finitura del vetro.
(es. F0.000/A)

* Match the letter to the code to
specify the type of glass finish
required.(es. F0.000/A)

CIRCLE R9 SOFFITTO-PARETE / CEILING-WALL

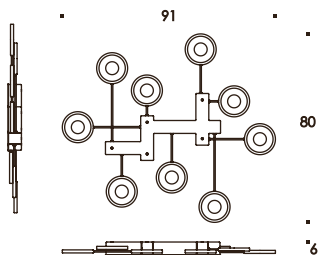

CODICE/CODE

€

€+IVA

LAMPADINA/BULB

INFO

F3.033* CROMO PERLATO
PEARLED CHROME

1.099,00

1.340,78

48 LED x9 34,6W
 bianco caldo
warm white
3000K



PESO/WEIGHT
8,5 kg
18,74 lbs

IMBALLO/BOX (cm)
110x110x20

VOLUME/VOLUME
0,242 m³

CLASSE ENERGETICA
ENERGY EFFICIENCY CLASS
A⁺⁺ - A (LED)

ALIMENTAZIONE
POWER SUPPLY
110V 50/60Hz
240V 50/60Hz

XX.XXX /**A** con vetri trasparenti
with transparent glass

XX.XXX /**B** con vetri satinati
with satin glass

* Accostare la lettera per
specificare la finitura del vetro.
(es. F0.000/A)

* Match the letter to the code to
specify the type of glass finish
required.(es. F0.000/A)

EOLO

Lampada a parete o soffitto con montaggio a luce soffusa. Struttura in metallo a supporto del diffusore in vetro bianco satinato.
Fermavetro in metallo con finitura cromo.

Lamp with emission of suffused lighting with diffuser in satin white opaline glass.
Sealing-glass in metal with chrome finishing.

EOLO SMALL

SOFFITTO-PARETE / CEILING-WALL

CODICE/CODE

€

€+IVA

LAMPADINA/BULB

INFO

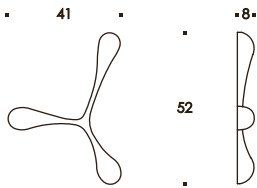

F3.031 BIANCO SATINATO
SATIN WHITE

319,00

389,18

G9 Halopin
MAX 3x60W

G9 Halopin
energy saving
MAX 3x48W



PESO/WEIGHT
1,6 kg
3,53 lbs

IMBALLO/BOX (cm)
60x60x20

VOLUME/VOLUME
0,072 m³

CLASSE ENERGETICA
ENERGY EFFICIENCY CLASS
C , D

ALIMENTAZIONE
POWER SUPPLY
230V 50/60Hz

EOLO MAX

SOFFITTO-PARETE / CEILING-WALL

CODICE/CODE

€

€+IVA

LAMPADINA/BULB

INFO

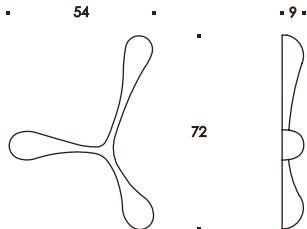

F3.032 BIANCO SATINATO
SATIN WHITE

374,00

456,28

G9 Halopin
MAX 3x75W

G9 Halopin
energy saving
MAX 3x60W



PESO/WEIGHT
2,0 kg
4,41 lbs

IMBALLO/BOX (cm)
70x70x20

VOLUME/VOLUME
0,098 m³

CLASSE ENERGETICA
ENERGY EFFICIENCY CLASS
C , D







ALIMENTAZIONE
POWER SUPPLY
230V 50/60Hz

EXA

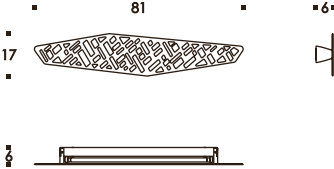
Lampada ad emissione di luce indiretta. Frontale in metallo bianco lucido o nero lucido con intagli satinati. Struttura in metallo con finitura bianco o nero.

Wall lamp with fitting that provides indirect light. Front in glossy white or black metal with satin carvings. Metal structure with white or black finish.

EXA SMALL PARETE / WALL

	CODICE/CODE	€	€+IVA	LAMPADINA/BULB	INFO	
	F3.057 BIANCO WHITE	395,00	481,90	 T5 1x24W	   	PESO/WEIGHT 4,3 kg 9,48 lbs IMBALLO/BOX (cm) 90x20x13 VOLUME/VOLUME 0,023 m ³ CLASSE ENERGETICA ENERGY EFFICIENCY CLASS A ⁺ ALIMENTAZIONE POWER SUPPLY 230V 50/60Hz
	F3.058 NERO BLACK	395,00	481,90			

EXA MAX PARETE / WALL

	CODICE/CODE	€	€+IVA	LAMPADINA/BULB	INFO	
	F3.055 BIANCO WHITE	559,00	681,98	 T5 1x39W	   	PESO/WEIGHT 6,6 kg 14,55 lbs IMBALLO/BOX (cm) 135x30x13 VOLUME/VOLUME 0,051 m ³ CLASSE ENERGETICA ENERGY EFFICIENCY CLASS A ⁺ ALIMENTAZIONE POWER SUPPLY 230V 50/60Hz
	F3.056 NERO BLACK	559,00	681,98			

FREE

Lampada a luce diretta. Costituita da una struttura in MDF e metallo opaco, e un vetro con una lavorazione particolare che assorbe e trasmette la luce LED. Tecnologia LED. Fonte di luce brevettato®.

Lamp with fitting that provides direct light. Made by a structure in MDF and matte metal, and by a glass with a specific detail that absorbs and projects the LED light. LED technology. Patented light source®.

KIT INCASSO BUILT-IN KIT

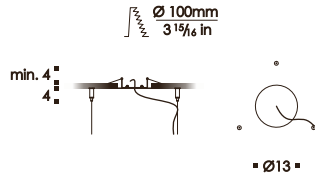

	CODICE/CODE	€	€+IVA	LAMPADINA/BULB	INFO
	F1.041 BIANCO WHITE	23,00	28,06		<p>PESO/WEIGHT 0,4 kg 0,83 lbs</p> <p>IMBALLO/BOX (cm) 20x20x10</p> <p>VOLUME/VOLUME 0,004 m³</p>
	F1.042 MOKA MOKA	23,00	28,06		
	F1.043 ROSSO R E D	23,00	28,06		
	F1.044 FOGLIA ORO GOLD LEAF	33,00	40,26		

FREE /35 SOSPENSIONE / HANGING LAMP

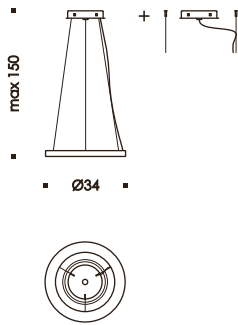

	CODICE/CODE	€	€+IVA	LAMPADINA/BULB	INFO
	F1.025 BIANCO WHITE	470,00	573,40	<p>174 LED 21,3W ■ bianco caldo warm white 3000K</p> <p>SU RICHIESTA - REQUEST *: potenza power 8,2W</p> <p>* Accostare la lettera 'D' al codice delle lampade standard (es. F0.000/D).</p> <p>* Put the letter "D" near the code of standard lamps (e.g. F0.000/D).</p>	<p>PESO/WEIGHT 5,0 kg 11,02 lbs</p> <p>IMBALLO/BOX (cm) box 55x55x15</p> <p>VOLUME/VOLUME 0,045 m³</p> <p>CLASSE ENERGETICA ENERGY EFFICIENCY CLASS A⁺⁺ - A (LED)</p> <p>ALIMENTAZIONE POWER SUPPLY 110V 50/60Hz 240V 50/60Hz</p>
	F1.026 MOKA MOKA	470,00	573,40		
	F1.027 ROSSO R E D	470,00	573,40		
	F1.028 FOGLIA ORO GOLD LEAF	510,00	622,20		

FREE /60 SOSPENSIONE / HANGING LAMP

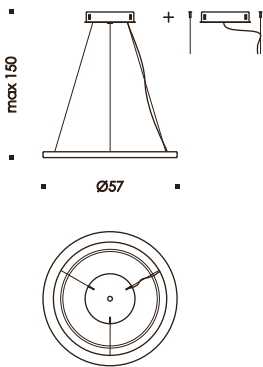

	CODICE/CODE	€	€+IVA	LAMPADINA/BULB	INFO
	F1.029 BIANCO WHITE	598,00	729,56	<p>324 LED 38,9 W ■ bianco caldo warm white 3000K</p> <p>SU RICHIESTA - REQUEST *: potenza power 15,1W</p> <p>* Accostare la lettera 'D' al codice delle lampade standard (es. F0.000/D).</p> <p>* Put the letter "D" near the code of standard lamps (e.g. F0.000/D).</p>	<p>PESO/WEIGHT 8,0 kg 17,64 lbs</p> <p>IMBALLO/BOX (cm) box 70x70x20</p> <p>VOLUME/VOLUME 0,098 m³</p> <p>CLASSE ENERGETICA ENERGY EFFICIENCY CLASS A⁺⁺ - A (LED)</p> <p>ALIMENTAZIONE POWER SUPPLY 110V 50/60Hz 240V 50/60Hz dimmerabile/dimmable</p>
	F1.030 MOKA MOKA	598,00	729,56		
	F1.031 ROSSO R E D	598,00	729,56		
	F1.032 FOGLIA ORO GOLD LEAF	646,00	788,12		

FREE /80 SOFFITTO / CEILING LAMP

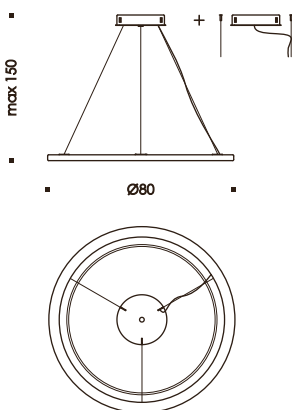

	CODICE/CODE	€	€+IVA	LAMPADINA/BULB	INFO
	F1.033 BIANCO WHITE	828,00	1.010,16	<p>468 LED 56,2W ■ bianco caldo warm white 3000K</p> <p>SU RICHIESTA - REQUEST *: potenza power 22,1W</p> <p>* Accostare la lettera 'D' al codice delle lampade standard (es. F0.000/D).</p> <p>* Put the letter "D" near the code of standard lamps (e.g. F0.000/D).</p>	<p>PESO/WEIGHT 10,7 kg 23,59 lbs</p> <p>IMBALLO/BOX (cm) box 90x90x20</p> <p>VOLUME/VOLUME 0,162 m³</p> <p>CLASSE ENERGETICA ENERGY EFFICIENCY CLASS A⁺⁺ - A (LED)</p> <p>ALIMENTAZIONE POWER SUPPLY 110V 50/60Hz 240V 50/60Hz dimmerabile/dimmable</p>
	F1.034 MOKA MOKA	828,00	1.010,16		
	F1.035 ROSSO R E D	828,00	1.010,16		
	F1.036 FOGLIA ORO GOLD LEAF	887,00	1.082,14		

FREE /100
SOSPENSIONE / HANGING LAMP

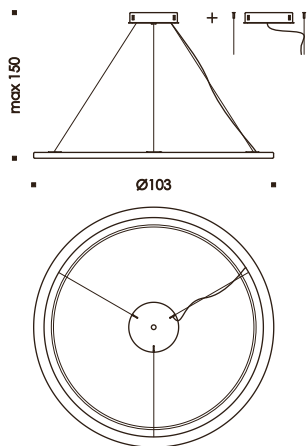

CODICE/CODE	€	€+IVA	LAMPADINA/BULB	INFO
F1.037 BIANCO WHITE	1.120,00	1.366,40	618 LED 74,2W	<p>CE</p> <p>PESO/WEIGHT 13,5 kg 29,76 lbs</p> <p>IMBALLO/BOX (cm) box 110x110x20</p> <p>VOLUME/VOLUME 0,242 m³</p> <p>CLASSE ENERGETICA ENERGY EFFICIENCY CLASS A++ - A (LED)</p> <p>ALIMENTAZIONE POWER SUPPLY 110V 50/60Hz 240V 50/60Hz dimmerabile/dimmable</p>
F1.038 MOKA MOKA	1.120,00	1.366,40	■ bianco caldo warm white 3000K	
F1.039 ROSSO RED	1.120,00	1.366,40		
F1.040 FOGLIA ORO GOLD LEAF	1.240,00	1.512,80		
			<p>SU RICHIESTA - REQUEST*: potenza power 29W</p> <p>* Accostare la lettera 'D' al codice delle lampade standard (es. F0.000/D).</p> <p>* Put the letter "D" near the code of standard lamps (e.g. F0.000/D).</p>	

FREE X2 /60
SOSPENSIONE / HANGING LAMP

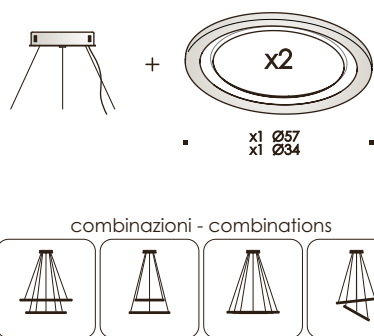

CODICE/CODE	€	€+IVA	LAMPADINA/BULB	INFO
F1.045 BIANCO WHITE	898,00	1.095,56	324+174 LED 60,2W	<p>CE</p> <p>PESO/WEIGHT 12,1 kg 26,68 lbs</p> <p>IMBALLO/BOX (cm) box 70x70x20</p> <p>VOLUME/VOLUME 0,098 m³</p> <p>CLASSE ENERGETICA ENERGY EFFICIENCY CLASS A++ - A (LED)</p> <p>ALIMENTAZIONE POWER SUPPLY 110V 50/60Hz 240V 50/60Hz dimmerabile/dimmable</p>
F1.046 MOKA MOKA	898,00	1.095,56	■ bianco caldo warm white 3000K	
F1.047 ROSSO RED	898,00	1.095,56		
F1.048 FOGLIA ORO GOLD LEAF	986,00	1.202,92		
			<p>SU RICHIESTA - REQUEST*: potenza power 23,3W</p> <p>* Accostare la lettera 'D' al codice delle lampade standard (es. F0.000/D).</p> <p>* Put the letter "D" near the code of standard lamps (e.g. F0.000/D).</p>	

FREE X2 /80
SOSPENSIONE / HANGING LAMP

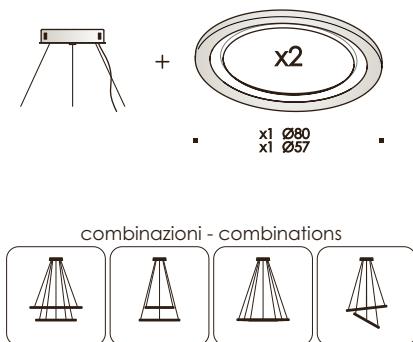

CODICE/CODE	€	€+IVA	LAMPADINA/BULB	INFO
F1.049 BIANCO WHITE	1.193,00	1.455,46	468+324 LED 95,1W	<p>CE</p> <p>PESO/WEIGHT 16,5 kg 36,38 lbs</p> <p>IMBALLO/BOX (cm) box 90x90x20</p> <p>VOLUME/VOLUME 0,162 m³</p> <p>CLASSE ENERGETICA ENERGY EFFICIENCY CLASS A++ - A (LED)</p> <p>ALIMENTAZIONE POWER SUPPLY 110V 50/60Hz 240V 50/60Hz dimmerabile/dimmable</p>
F1.050 MOKA MOKA	1.193,00	1.455,46	■ bianco caldo warm white 3000K	
F1.051 ROSSO RED	1.193,00	1.455,46		
F1.052 FOGLIA ORO GOLD LEAF	1.200,00	1.464,00		
			<p>SU RICHIESTA - REQUEST*: potenza power 37,2W</p> <p>* Accostare la lettera 'D' al codice delle lampade standard (es. F0.000/D).</p> <p>* Put the letter "D" near the code of standard lamps (e.g. F0.000/D).</p>	

FREE X2 /100
SOFFITTO / CEILING LAMP

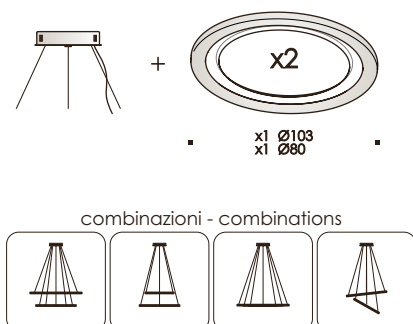

CODICE/CODE	€	€+IVA	LAMPADINA/BULB	INFO
F1.053 BIANCO WHITE	1.700,00	2.074,00	618+468 LED 130,4W	<p>CE</p> <p>PESO/WEIGHT 20,9 kg 46,08 lbs</p> <p>IMBALLO/BOX (cm) box 110x110x20</p> <p>VOLUME/VOLUME 0,242 m³</p> <p>CLASSE ENERGETICA ENERGY EFFICIENCY CLASS A++ - A (LED)</p> <p>ALIMENTAZIONE POWER SUPPLY 110V 50/60Hz 240V 50/60Hz dimmerabile/dimmable</p>
F1.054 MOKA MOKA	1.700,00	2.074,00	■ bianco caldo warm white 3000K	
F1.055 ROSSO RED	1.700,00	2.074,00		
F1.056 FOGLIA ORO GOLD LEAF	1.880,00	2.293,60		
			<p>SU RICHIESTA - REQUEST*: potenza power 51,1W</p> <p>* Accostare la lettera 'D' al codice delle lampade standard (es. F0.000/D).</p> <p>* Put the letter "D" near the code of standard lamps (e.g. F0.000/D).</p>	

FREE X3 /80 SOSPENSIONE / HANGING LAMP

CODICE/CODE

€

€+IVA

LAMPADINA/BULB

INFO

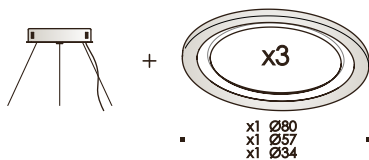

combinazioni - combinations



F1.057	BIANCO WHITE	1.539,00	1.877,58
F1.058	MOKA MOKA	1.539,00	1.877,58
F1.059	ROSSO RED	1.539,00	1.877,58
F1.060	FOGLIA ORO GOLD LEAF	1.687,00	2.058,14

468+324+174 LED
116,4W

bianco caldo
warm white
3000K

SU RICHIESTA - REQUEST *:
potenza
power 45,4W

* Accostare la lettera 'D' al
codice delle lampade
standard (es. F0.000/D).

* Put the letter "D" near the
code of standard lamps
(e.g. F0.000/D).



PESO/WEIGHT
19,0 kg
41,89 lbs

IMBALLO/BOX (cm)
box 90x90x20

VOLUME/VOLUME
0,162 m³

CLASSE ENERGETICA
ENERGY EFFICIENCY CLASS
A++ - A (LED)

ALIMENTAZIONE
POWER SUPPLY
110V 50/60Hz
240V 50/60Hz
dimmerabile/dimmable

FREE X3 /100 SOSPENSIONE / HANGING LAMP

CODICE/CODE

€

€+IVA

LAMPADINA/BULB

INFO

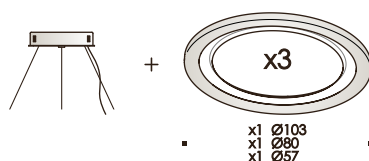

combinazioni - combinations



F1.061	BIANCO WHITE	2.115,00	2.580,30
F1.062	MOKA MOKA	2.115,00	2.580,30
F1.063	ROSSO RED	2.115,00	2.580,30
F1.064	FOGLIA ORO GOLD LEAF	2.345,00	2.860,90

618+468+324 LED
169,3W

bianco caldo
warm white
3000K

SU RICHIESTA - REQUEST *:
potenza
power 66,2W

* Accostare la lettera 'D' al
codice delle lampade
standard (es. F0.000/D).

* Put the letter "D" near the
code of standard lamps
(e.g. F0.000/D).



PESO/WEIGHT
25,1 kg
55,34 lbs

IMBALLO/BOX (cm)
box 110x110x20

VOLUME/VOLUME
0,242 m³

CLASSE ENERGETICA
ENERGY EFFICIENCY CLASS
A++ - A (LED)

ALIMENTAZIONE
POWER SUPPLY
110V 50/60Hz
240V 50/60Hz
dimmerabile/dimmable

GAME

Lampada da appoggio con luce diretta. Costituita da un vetro con una lavorazione particolare che assorbe e trasmette la luce LED. Struttura in MDF e metallo verniciati opaco. Accensione e dimmerazione tramite pulsante capacitivo. Tecnologia LED. Fonte di luce brevettato ®.

Table lamp with fitting that provides direct light. Made by a glass with a specific detail that absorbs and projects the LED light. Structure in MDF and matte metal. Lighting and dimming through a touch dimmer button. LED technology. Patented light source ®.

LITTLE GAME APPOGGIO/TABLE

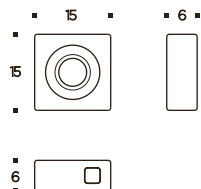

CODICE/CODE	€	€+IVA	LAMPADINA/BULB	INFO
F4.001 BIANCO WHITE	280,00	341,60	48 LED 3,9W ■ bianco caldo warm white 3000K	PESO/WEIGHT 2,0 kg 4,41 lbs IMBALLO/BOX (cm) 25x22x13 VOLUME/VOLUME 0,007 m³ CLASSE ENERGETICA ENERGY EFFICIENCY CLASS A++ - A (LED) ALIMENTAZIONE POWER SUPPLY 110V 50/60Hz 240V 50/60Hz Alimentatore a spina (2 poli EURO) per presa a muro. Power supply manufacturer wall- mounted type (2 pole EURO plug).
F4.003 NERO BLACK	280,00	341,60		
F4.009 MOKA MOKA	280,00	341,60		
F4.005 ROSSO RED	280,00	341,60		
F4.007 VERDE ZOLFO SULPHUR GREEN	280,00	341,60		

GAME APPOGGIO / TABLE

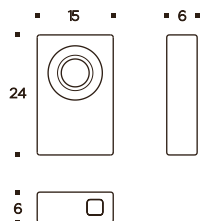

CODICE/CODE	€	€+IVA	LAMPADINA/BULB	INFO
F4.011 BIANCO WHITE	330,00	402,60	78 LED 9,8W ■ bianco caldo warm white 3000K	PESO/WEIGHT 3,0 kg 6,61 lbs IMBALLO/BOX (cm) 35x22x13 VOLUME/VOLUME 0,010 m³ CLASSE ENERGETICA ENERGY EFFICIENCY CLASS A++ - A (LED) ALIMENTAZIONE POWER SUPPLY 110V 50/60Hz 240V 50/60Hz Alimentatore a spina (2 poli EURO) per presa a muro. Power supply manufacturer wall- mounted type (2 pole EURO plug).
F4.019 MOKA MOKA	330,00	402,60		

GAME

Lampada con luce diretta. Costituita da un vetro con un taglio particolare che assorbe e trasmette la luce LED. Corpo inclinabile. Struttura in MDF e metallo verniciati opaco. Tecnologia LED. Fonte di luce brevettato ®.

Wall lamp with fitting that provides direct light. Made by a glass with a specific detail that absorbs and projects the LED light. Tiltable body. Structure in MDF and matte metal. LED technology. Patented light source ®.

GAME PARETE / WALL

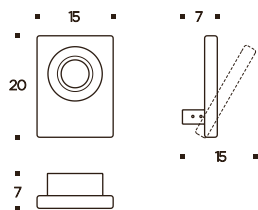







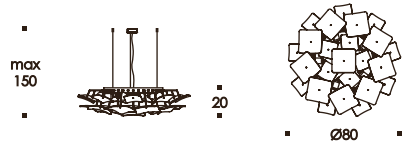

CODICE/CODE	€	€+IVA	LAMPADINA/BULB	INFO
F3.049 BIANCO WHITE	265,00	323,30	78 LED 9,8W ■ bianco caldo warm white 3000K	PESO/WEIGHT 2,5 kg 5,51 lbs IMBALLO/BOX (cm) 35x22x13 VOLUME/VOLUME 0,010 m³ CLASSE ENERGETICA ENERGY EFFICIENCY CLASS A++ - A (LED) ALIMENTAZIONE POWER SUPPLY 110V 50/60Hz 240V 50/60Hz
F3.053 MOKA MOKA	265,00	323,30		





KB

Lampada con montaggio a luce diretta. Vetri cattedrali bianchi o multicolore. Struttura in metallo con finitura cromo.

Lamp with direct light. Stained glass effect white or multicolour. Metal structure with chrome finishing.

KB 80 SOSPENSIONE / HANGING LAMP		CODICE/CODE	€	€+IVA	LAMPADINA/BULB	INFO
	KIT HANGING T1.001*		196,00	239,19	 E27 MAX 7x100W	 PESO/WEIGHT 15,5 kg 34,17 lbs
	LAMP T3.022* BIANCO WHITE		1.065,00	1.299,30	 E27 energy saving MAX 7x21W	IMBALLO/BOX (cm) box ¹ 70x70x20 box ² 55x55x15 VOLUME/VOLUME 0,143 m ³
	T3.021* MULTICOLORE MULTICOLOUR		1.065,00	1.299,30	 E27 LED MAX 7x11W	CLASSE ENERGETICA ENERGY EFFICIENCY CLASS A ⁺ - E ALIMENTAZIONE POWER SUPPLY 230V 50/60Hz
<p>* La versione sospensione è formata dalla lampada e dal kit sospensione. All'atto dell'ordine includere entrambi i codici.</p> <p>* The hanging lamp is formed by the lamp and the hanging lamp kit. In the order include both codes please.</p>						

KB 100 SOSPENSIONE / HANGING LAMP		CODICE/CODE	€	€+IVA	LAMPADINA/BULB	INFO
	KIT HANGING T1.001*		196,00	239,19	 E27 MAX 7x100W	 PESO/WEIGHT 17,5 kg 38,58 lbs
	LAMP T3.020* BIANCO WHITE		1.331,00	1.623,82	 E27 energy saving MAX 7x21W	IMBALLO/BOX (cm) box ¹ 70x70x20 box ² 55x55x15 VOLUME/VOLUME 0,143 m ³
	T3.019* MULTICOLORE MULTICOLOUR		1.331,00	1.623,82	 E27 LED MAX 7x11W	CLASSE ENERGETICA ENERGY EFFICIENCY CLASS A ⁺ - E ALIMENTAZIONE POWER SUPPLY 230V 50/60Hz
<p>* La versione sospensione è formata dalla lampada e dal kit sospensione. All'atto dell'ordine includere entrambi i codici.</p> <p>* The hanging lamp is formed by the lamp and the hanging lamp kit. In the order include both codes please.</p>						



KB 130 SOSPENSIONE / HANGING LAMP		CODICE/CODE	€	€+IVA	LAMPADINA/BULB	INFO
	KIT HANGING T1.001*		196,00	239,19	 E27 MAX 7x100W	 PESO/WEIGHT 20,5 kg 45,19 lbs
	LAMP T3.018* BIANCO WHITE		1.788,00	2.181,36	 E27 energy saving MAX 7x21W	IMBALLO/BOX (cm) box ¹ 70x70x20 box ² 55x55x15 VOLUME/VOLUME 0,143 m ³
	T3.017* MULTICOLORE MULTICOLOUR		1.788,00	2.181,36	 E27 LED MAX 7x11W	CLASSE ENERGETICA ENERGY EFFICIENCY CLASS A ⁺ - E ALIMENTAZIONE POWER SUPPLY 230V 50/60Hz
<p>* La versione sospensione è formata dalla lampada e dal kit sospensione. All'atto dell'ordine includere entrambi i codici.</p> <p>* The hanging lamp is formed by the lamp and the hanging lamp kit. In the order include both codes please.</p>						

KB 80 SOFFITTO-PARETE / CEILING-WALL		CODICE/CODE	€	€+IVA	LAMPADINA/BULB	INFO
	T3.022 BIANCO WHITE		1.065,00	1.299,30	 E27 MAX 7x100W	 PESO/WEIGHT 13,0 kg 28,66 lbs
	T3.021 MULTICOLORE MULTICOLOUR		1.065,00	1.299,30	 E27 energy saving MAX 7x21W	IMBALLO/BOX (cm) box ¹ 70x70x20 VOLUME/VOLUME 0,098 m ³
					 E27 LED MAX 7x11W	CLASSE ENERGETICA ENERGY EFFICIENCY CLASS A ⁺ - E ALIMENTAZIONE POWER SUPPLY 230V 50/60Hz

KB 100 SOFFITTO-PARETE / CEILING-WALL		CODICE/CODE	€	€+IVA	LAMPADINA/BULB	INFO
 <p>Ø100 20</p>	T3.020	BIANCO WHITE	1.331,00	1.623,82	 E27 MAX 7x100W	PESO/WEIGHT 15,0 kg 33,07 lbs IMBALLO/BOX (cm) box 70x70x20 VOLUME/VOLUME 0,098 m ³ CLASSE ENERGETICA ENERGY EFFICIENCY CLASS A ⁺ - E ALIMENTAZIONE POWER SUPPLY 230V 50/60Hz
	T3.019	MULTICOLORE MULTICOLOUR	1.331,00	1.623,82	 E27 energy saving MAX 7x21W  E27 LED MAX 7x11W	

KB 130 SOFFITTO-PARETE / CEILING-WALL		CODICE/CODE	€	€+IVA	LAMPADINA/BULB	INFO
 <p>Ø130 20</p>	T3.018	BIANCO WHITE	1.788,00	2.181,36	 E27 MAX 7x100W	PESO/WEIGHT 18,0 kg 39,68 lbs IMBALLO/BOX (cm) box 70x70x20 VOLUME/VOLUME 0,098 m ³ CLASSE ENERGETICA ENERGY EFFICIENCY CLASS A ⁺ - E ALIMENTAZIONE POWER SUPPLY 230V 50/60Hz
	T3.017	MULTICOLORE MULTICOLOUR	1.788,00	2.181,36	 E27 energy saving MAX 7x21W  E27 LED MAX 7x11W	

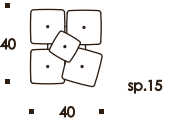
KB LINEARE SOFFITTO-PARETE / CEILING-WALL		CODICE/CODE	€	€+IVA	LAMPADINA/BULB	INFO
 <p>90 sp 15 35</p>	T3.040	BIANCO WHITE	428,00	522,16	 G9 Halopin MAX 5x75W	PESO/WEIGHT 5,5 kg 12,13 lbs IMBALLO/BOX (cm) box 90x40x25 VOLUME/VOLUME 0,090 m ³ CLASSE ENERGETICA ENERGY EFFICIENCY CLASS C - D ALIMENTAZIONE POWER SUPPLY 230V 50/60Hz
	T3.039	MULTICOLORE MULTICOLOUR	428,00	522,16	 G9 Halopin energy saving MAX 5x60W	

KB QUADRO SMALL SOFFITTO-PARETE / CEILING-WALL		CODICE/CODE	€	€+IVA	LAMPADINA/BULB	INFO
 <p>40 sp.15 40</p>	T3.041	BIANCO WHITE	281,00	342,82	 G9 Halopin MAX 4x60W	PESO/WEIGHT 3,5 kg 7,72 lbs IMBALLO/BOX (cm) box 47x47x23 VOLUME/VOLUME 0,051 m ³ CLASSE ENERGETICA ENERGY EFFICIENCY CLASS C - D ALIMENTAZIONE POWER SUPPLY 230V 50/60Hz
	T3.085	MULTICOLORE MULTICOLOUR	281,00	342,82	 G9 Halopin energy saving MAX 4x48W	

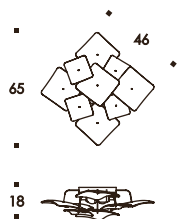
KB QUADRO MAX
 SOFFITTO-PARETE / CEILING-WALL

CODICE/CODE

€

€+IVA

LAMPADINA/BULB

INFO

T3.043 BIANCO
WHITE

T3.042 MULTICOLORE
MULTICOLOUR

398,00
485,56
398,00
485,56

 E27 MAX 2x100W

 E27 energy saving
MAX 2x21W

 E27 LED MAX 2x11W

 PESO/WEIGHT
4,5 kg
9,92 lbs

 IMBALLO/BOX (cm)
box 47x47x23

 VOLUME/VOLUME
0,051 m³

 CLASSE ENERGETICA
ENERGY EFFICIENCY CLASS
A⁺ - E

 ALIMENTAZIONE
POWER SUPPLY
230V 50/60Hz

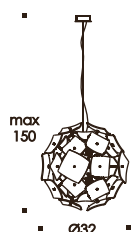
KB SFERA SMALL
 SOSPENSIONE / HANGING LAMP

CODICE/CODE

€

€+IVA

LAMPADINA/BULB

INFO

T1.021 BIANCO
WHITE

T1.020 MULTICOLORE
MULTICOLOUR

628,00
766,16
628,00
766,16

 G9 Halopin
MAX 4x40W

 G9 Halopin
energy saving
MAX 4x33W

 PESO/WEIGHT
5,5 kg
12,13 lbs

 IMBALLO/BOX (cm)
box 46x40x43

 VOLUME/VOLUME
0,079 m³

 CLASSE ENERGETICA
ENERGY EFFICIENCY CLASS
C - D

 ALIMENTAZIONE
POWER SUPPLY
230V 50/60Hz

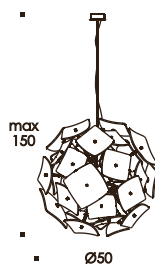
KB SFERA MAX
 SOSPENSIONE / HANGING LAMP

CODICE/CODE

€

€+IVA

LAMPADINA/BULB

INFO

T1.023 BIANCO
WHITE

T1.022 MULTICOLORE
MULTICOLOUR

898,00
1.095,56
898,00
1.095,56

 E14 MAX 4x60W

 E14 LED MAX 4x4W

 PESO/WEIGHT
10,0 kg
22,05 lbs

 IMBALLO/BOX (cm)
box 50x50x70

 VOLUME/VOLUME
0,175 m³

 CLASSE ENERGETICA
ENERGY EFFICIENCY CLASS
A⁺ - E

 ALIMENTAZIONE
POWER SUPPLY
230V 50/60Hz

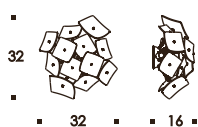
KB SFERA SMALL
 SOFFITTO-PARETE / CEILING-WALL

CODICE/CODE

€

€+IVA

LAMPADINA/BULB

INFO

T3.071 BIANCO
WHITE

T3.070 MULTICOLORE
MULTICOLOUR

298,00
363,56
298,00
363,56

 G9 Halopin
MAX 2x60W

 G9 Halopin
energy saving
MAX 2x48W

 PESO/WEIGHT
2,5 kg
5,51 lbs

 IMBALLO/BOX (cm)
box 40x40x28

 VOLUME/VOLUME
0,045 m³

 CLASSE ENERGETICA
ENERGY EFFICIENCY CLASS
C - D

 ALIMENTAZIONE
POWER SUPPLY
230V 50/60Hz

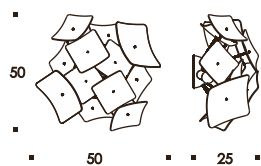
KB SFERA MAX
SOFFITTO-PARETE / CEILING-WALL

	CODICE/CODE	€	€+IVA	LAMPADINA/BULB	INFO
T3.073	BIANCO WHITE	429,00	523,38	 E14 MAX 2x60W	CE PC F IP20 ⚡
T3.072	MULTICOLORE MULTICOLOUR	429,00	523,38	 E14 LED MAX 2x4W	
PESO/WEIGHT 4,5 kg 9,92 lbs IMBALLO/BOX (cm) box 50x60x25 VOLUME/VOLUME 0,075 m ³ CLASSE ENERGETICA ENERGY EFFICIENCY CLASS A+ - E ALIMENTAZIONE POWER SUPPLY 230V 50/60Hz					

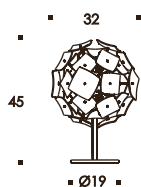
KB SFERA
TAVOLO / TABLE LAMP

	CODICE/CODE	€	€+IVA	LAMPADINA/BULB	INFO
T4.006	BIANCO WHITE	616,00	751,52	 G9 Halopin MAX 4x40W	CE PC F IP20 ⚡
T4.005	MULTICOLORE MULTICOLOUR	616,00	751,52	 G9 Halopin energy saving MAX 4x33W	
PESO/WEIGHT 6 kg 11,02 lbs IMBALLO/BOX (cm) box 46x40x43 VOLUME/VOLUME 0,079 m ³ CLASSE ENERGETICA ENERGY EFFICIENCY CLASS C - D ALIMENTAZIONE POWER SUPPLY 230V 50/60Hz					

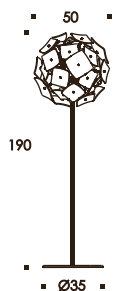
KB SFERA
TERRA / FLOOR

	CODICE/CODE	€	€+IVA	LAMPADINA/BULB	INFO
T2.016	BIANCO WHITE	1.276,00	1.556,72	 E14 MAX 4x60W	CE PC F IP20 ⚡ ⌚
T2.015	MULTICOLORE MULTICOLOUR	1.276,00	1.556,72		
PESO/WEIGHT 14,0 kg 30,86 lbs IMBALLO/BOX (cm) box ¹ 50x50x70 box ² Ø13x184 VOLUME/VOLUME 0,190 m ³ CLASSE ENERGETICA ENERGY EFFICIENCY CLASS C - D ALIMENTAZIONE POWER SUPPLY 230V 50/60Hz DIMMERABLE LIGHT					

LINE

Lampada a luce diretta, con sorgente luminosa in vetro temperato con satinatura.
Struttura in metallo con finitura cromo perlato.
Tecnologia a led.

Lamp with direct light, with the light source in tempered glass with satin finish.
Metal frame with chrome finish pearl.
LED technology.

LINE SMALL SOSPENSIONE / HANGING LAMP

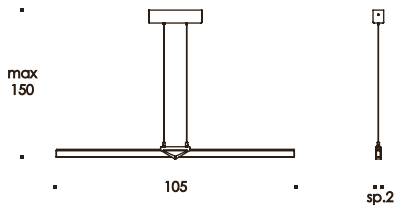

CODICE/CODE	€	€+IVA	LAMPADINA/BULB	INFO
F1.002 VETRO TEMPERATO TEMPERED GLASS	608,00	741,76	204 LED 24,5W ■ bianco caldo warm white 3000K	PESO/WEIGHT 3,5 kg 7,72 lbs IMBALLO/BOX (cm) 120x25x11 VOLUME/VOLUME 0,033 m ³ CLASSE ENERGETICA ENERGY EFFICIENCY CLASS A ⁺⁺ - A (LED) ALIMENTAZIONE POWER SUPPLY 110V 50/60Hz 240V 50/60Hz
dimmerabile/dimmable F1.017 VETRO TEMPERATO TEMPERED GLASS	608,00	741,76	SU RICHIESTA: R E Q U E S T : □ bianco naturale natural white 4200K	

LINE MAX SOSPENSIONE / HANGING LAMP

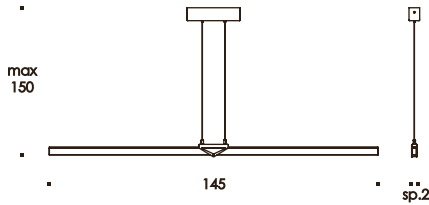

CODICE/CODE	€	€+IVA	LAMPADINA/BULB	INFO
F1.003 VETRO TEMPERATO TEMPERED GLASS	693,00	845,46	228 LED 34,3W ■ bianco caldo warm white 3000K	PESO/WEIGHT 4,0 kg 8,82 lbs IMBALLO/BOX (cm) 160x25x11 VOLUME/VOLUME 0,044 m ³ CLASSE ENERGETICA ENERGY EFFICIENCY CLASS A ⁺⁺ - A (LED) ALIMENTAZIONE POWER SUPPLY 110V 50/60Hz 240V 50/60Hz
dimmerabile/dimmable F1.018 VETRO TEMPERATO TEMPERED GLASS	693,00	845,46	SU RICHIESTA: R E Q U E S T : □ bianco naturale natural white 4200K	

LINE /55 PARETE / WALL LAMP

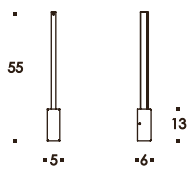

CODICE/CODE	€	€+IVA	LAMPADINA/BULB	INFO
F3.003 VETRO TEMPERATO TEMPERED GLASS	364,00	444,08	48 LED 3,9W ■ bianco caldo warm white 3000K	PESO/WEIGHT 1,6 kg 3,53 lbs IMBALLO/BOX (cm) 60x25x11 VOLUME/VOLUME 0,017 m ³ CLASSE ENERGETICA ENERGY EFFICIENCY CLASS A ⁺⁺ - A (LED) ALIMENTAZIONE POWER SUPPLY 110V 50/60Hz 240V 50/60Hz
			SU RICHIESTA: R E Q U E S T : □ bianco naturale natural white 4200K	

LINE /75 PARETE / WALL LAMP

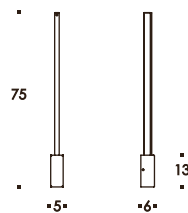

CODICE/CODE	€	€+IVA	LAMPADINA/BULB	INFO
F3.004 VETRO TEMPERATO TEMPERED GLASS	383,00	467,26	72 LED 5,8W ■ bianco caldo warm white 3000K	PESO/WEIGHT 2,0 kg 4,41 lbs IMBALLO/BOX (cm) 80x25x11 VOLUME/VOLUME 0,022 m ³ CLASSE ENERGETICA ENERGY EFFICIENCY CLASS A ⁺⁺ - A (LED) ALIMENTAZIONE POWER SUPPLY 110V 50/60Hz 240V 50/60Hz
			SU RICHIESTA: R E Q U E S T : □ bianco naturale natural white 4200K	

LINE /115
PARETE / WALL LAMP

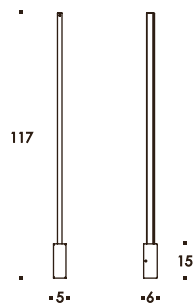

F3.005 VETRO TEMPERATO
TEMPERED GLASS

€ **410,00**

€+IVA **500,20**

LAMPADINA/BULB

120 LED 9,6W
 bianco caldo
warm white
3000K

SU RICHIESTA:
R E Q U E S T :
 bianco naturgle
natural white
4200K



PESO/WEIGHT
3,5 kg
7,72 lbs

IMBALLO/BOX (cm)
120x25x11

VOLUME/VOLUME
0,033 m³

CLASSE ENERGETICA
ENERGY EFFICIENCY CLASS
A++ - A (LED)

ALIMENTAZIONE
POWER SUPPLY
110V 50/60Hz
240V 50/60Hz

LINE /165
PARETE / WALL LAMP

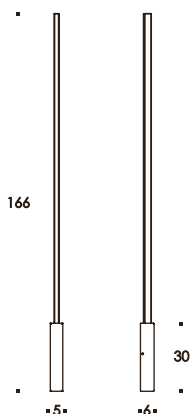

F3.006 VETRO TEMPERATO
TEMPERED GLASS

€ **626,00**

€+IVA **763,72**

LAMPADINA/BULB

276 LED 33,1W
 bianco caldo
warm white
3000K

SU RICHIESTA:
R E Q U E S T :
 bianco naturgle
natural white
4200K



PESO/WEIGHT
4,0 kg
8,82 lbs

IMBALLO/BOX (cm)
160x25x11

VOLUME/VOLUME
0,044 m³

CLASSE ENERGETICA
ENERGY EFFICIENCY CLASS
A++ - A (LED)

ALIMENTAZIONE
POWER SUPPLY
110V 50/60Hz
240V 50/60Hz

(predisposta per alimentarla tramite
spina elettrica) - (Arranged to be fed
with electric plug)

NICE

Lampada a parete, a soffitto o in sospensione con luce diretta. Struttura in metallo verniciato bianco lucido o viola lucido. Vetri con finitura bianco lucido, grigio lucido, arancio lucido, verde lucido, viola lucido.

Lamp with emission of direct lighting. Colored curved glass in gloss white, gloss grey, gloss purple, gloss green, gloss orange. Structure in metal with painted finish gross white or gloss purple.

NICE 80 SOSPENSIONE / HANGING LAMP

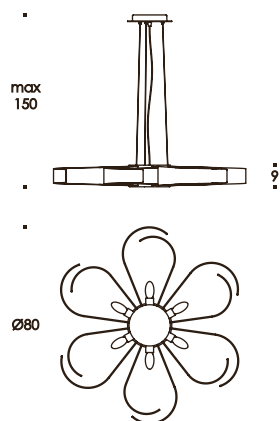

CODICE/CODE	€	€+IVA	LAMPADINA/BULB	INFO
F1.005 VIOLA/VIOLA/VIOLA* PURPLE/PURPLE/PURPLE	598,00	729,56	E14 MAX 6x60W	CE IMBALLO/BOX (cm) 55x55x35 VOLUME/VOLUME 0,106 m ³ CLASSE ENERGETICA ENERGY EFFICIENCY CLASS A+ - E ALIMENTAZIONE POWER SUPPLY 230V 50/60Hz
F1.004 BIANCO/BIANCO/BIANCO* WHITE/WHITE/WHITE	598,00	729,56	E14 MAX 6x60W	
F1.006 BIANCO/BIANCO/GRIGIO* WHITE/WHITE/GREY	598,00	729,56	E14 energy saving MAX 6x11W	
F1.007 BIANCO/BIANCO/ARANCIO* WHITE/WHITE/ORANGE	598,00	729,56	E14 energy saving MAX 6x11W	
F1.008 BIANCO/BIANCO/VERDE* WHITE/WHITE/GREEN	598,00	729,56	E14 LED MAX 6x4,5W	
F1.009 BIANCO/BIANCO/VIOLA* WHITE/WHITE/PURPLE	598,00	729,56	E14 LED MAX 6x4,5W	
*legenda/colors key: codice STRUTTURA/VETRO/VETRO STRUCTURE/GLASS/GLASS				

NICE 80 SOFFITTO-PARETE / CEILING-WALL

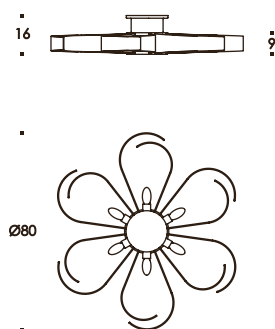

CODICE/CODE	€	€+IVA	LAMPADINA/BULB	INFO
F3.026 VIOLA/VIOLA/VIOLA* PURPLE/PURPLE/PURPLE	628,00	766,16	E14 MAX 6x60W	CE IMBALLO/BOX (cm) 55x55x35 VOLUME/VOLUME 0,106 m ³ CLASSE ENERGETICA ENERGY EFFICIENCY CLASS A+ - E ALIMENTAZIONE POWER SUPPLY 230V 50/60Hz
F3.025 BIANCO/BIANCO/BIANCO* WHITE/WHITE/WHITE	628,00	766,16	E14 MAX 6x60W	
F3.027 BIANCO/BIANCO/GRIGIO* WHITE/WHITE/GREY	628,00	766,16	E14 energy saving MAX 6x11W	
F3.028 BIANCO/BIANCO/ARANCIO* WHITE/WHITE/ORANGE	628,00	766,16	E14 energy saving MAX 6x11W	
F3.029 BIANCO/BIANCO/VERDE* WHITE/WHITE/GREEN	628,00	766,16	E14 LED MAX 6x4,5W	
F3.030 BIANCO/BIANCO/VIOLA* WHITE/WHITE/PURPLE	628,00	766,16	E14 LED MAX 6x4,5W	
*legenda/colors key: codice STRUTTURA/VETRO/VETRO STRUCTURE/GLASS/GLASS				

Pi.Kà 40 SOSPENSIONE / HANGING LAMP

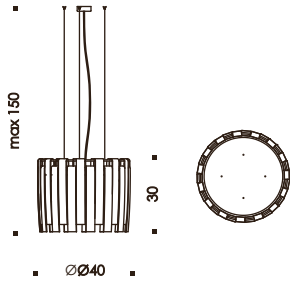

F1.019 BIANCO/NERO
WHITE/BLACK

€ 729,00

€+IVA 889,38

F1.020 MULTICOLORE
MULTICOLOUR

€ 729,00

€+IVA 889,38

Composizione vetri:
16 bianchi / 16 neri
32 multicolore

Glass composition:
16 white / 16 black
32 multicolour

E27 MAX 4x60W

E27 energy saving
MAX 4x11W

E27 LED MAX 4x10W



PESO/WEIGHT
8,0 kg
17,64 lbs

IMBALLO/BOX (cm)
50x65x40

VOLUME/VOLUME
0,130 m³

CLASSE ENERGETICA
ENERGY EFFICIENCY CLASS
A⁺ - E

ALIMENTAZIONE
POWER SUPPLY
230V 50/60Hz

Pi.Kà 60 SOSPENSIONE / HANGING LAMP

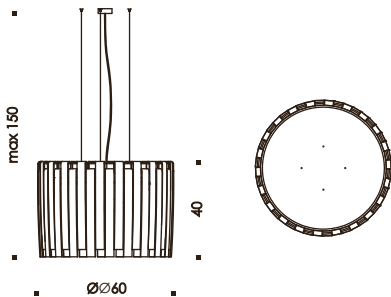

F1.021 BIANCO/NERO
WHITE/BLACK

€ 957,00

€+IVA 1.167,54

F1.022 MULTICOLORE
MULTICOLOUR

€ 957,00

€+IVA 1.167,54

Composizione vetri:
24 bianchi / 24 neri
48 multicolore

Glass composition:
24 white / 24 black
48 multicolour

E27 MAX 4x60W

E27 energy saving
MAX 4x11W

E27 LED MAX 4x10W



PESO/WEIGHT
12,0 kg
26,46 lbs

IMBALLO/BOX (cm)
box¹ 65x65x30
box² 50x65x40

VOLUME/VOLUME
0,256 m³

CLASSE ENERGETICA
ENERGY EFFICIENCY CLASS
A⁺ - E

ALIMENTAZIONE
POWER SUPPLY
230V 50/60Hz

Pi.Kà 80 SOSPENSIONE / HANGING LAMP

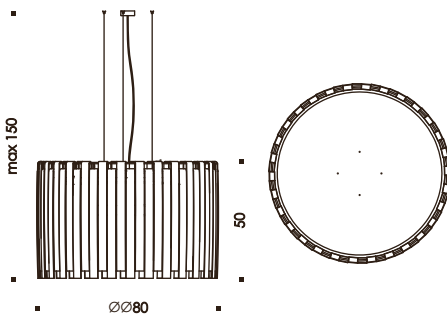

F1.023 BIANCO/NERO
WHITE/BLACK

€ 1.363,00

€+IVA 1.662,86

F1.024 MULTICOLORE
MULTICOLOUR

€ 1.363,00

€+IVA 1.662,86

Composizione vetri:
32 bianchi / 32 neri
64 multicolore

Glass composition:
32 white / 32 black
64 multicolour

E27 MAX 4x100W

E27 energy saving
MAX 4x21W

E27 LED MAX 4x11W



PESO/WEIGHT
18,0 kg
39,68 lbs

IMBALLO/BOX (cm)
box¹ 80x80x36
box² 65x65x30

VOLUME/VOLUME
0,356 m³

CLASSE ENERGETICA
ENERGY EFFICIENCY CLASS
A⁺ - E

ALIMENTAZIONE
POWER SUPPLY
230V 50/60Hz

Pi.Kà 40 SOFFITTO / CEILING LAMP

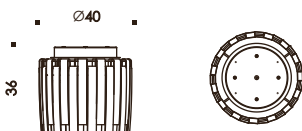

F3.042 BIANCO/NERO
WHITE/BLACK

€ 729,00

€+IVA 889,38

F3.043 MULTICOLORE
MULTICOLOUR

€ 729,00

€+IVA 889,38

Composizione vetri:
16 bianchi / 16 neri
32 multicolore

Glass composition:
16 white / 16 black
32 multicolour

E27 MAX 4x60W

E27 energy saving
MAX 4x11W

E27 LED MAX 4x10W



PESO/WEIGHT
8,0 kg
17,64 lbs





IMBALLO/BOX (cm)
box¹ 50x65x40

VOLUME/VOLUME
0,130 m³



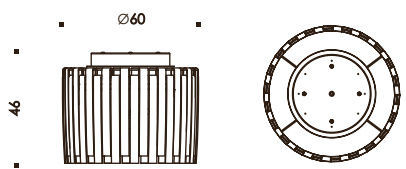

CLASSE ENERGETICA
ENERGY EFFICIENCY CLASS
A⁺ - E

ALIMENTAZIONE
POWER SUPPLY
230V 50/60Hz

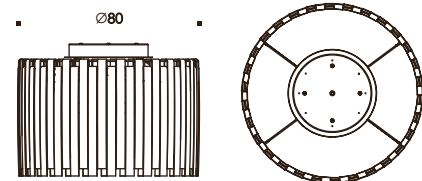

Pi.Kà 60 SOFFITTO / CEILING

	CODICE/CODE	€	€+IVA	LAMPADINA/BULB	INFO
	F3.044 BIANCO/NERO WHITE/BLACK	957,00	1.167,54	 E27 MAX 4x60W	PESO/WEIGHT 12,0 kg 26,46 lbs IMBALLO/BOX (cm) box ¹ 65x65x30 box ² 50x65x40 VOLUME/VOLUME 0,256 m ³ CLASSE ENERGETICA ENERGY EFFICIENCY CLASS A ⁺ - E ALIMENTAZIONE POWER SUPPLY 230V 50/60Hz
	F3.045 MULTICOLORE MULTICOLOUR	957,00	1.167,54	 E27 energy saving MAX 4x11W  E27 LED MAX 4x10W	
	Composizione vetri: 24 bianchi / 24 neri 48 multicolore Glass composition: 24 white / 24 black 48 multicolour				

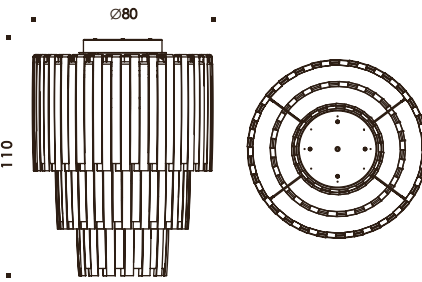

Pi.Kà 80 SOFFITTO / CEILING

	CODICE/CODE	€	€+IVA	LAMPADINA/BULB	INFO
	F3.046 BIANCO/NERO WHITE/BLACK	1.363,00	1.662,86	 E27 MAX 4x100W	PESO/WEIGHT 18,0 kg 39,68 lbs IMBALLO/BOX (cm) box ¹ 80x80x36 box ² 65x65x30 VOLUME/VOLUME 0,356 m ³ CLASSE ENERGETICA ENERGY EFFICIENCY CLASS A ⁺ - E ALIMENTAZIONE POWER SUPPLY 230V 50/60Hz
	F3.047 MULTICOLORE MULTICOLOUR	1.363,00	1.662,86	 E27 energy saving MAX 4x21W  E27 LED MAX 4x11W	
	Composizione vetri: 32 bianchi / 32 neri 64 multicolore Glass composition: 32 white / 32 black 64 multicolour				

Pi.Kà 800 SOFFITTO / CEILING

	CODICE/CODE	€	€+IVA	LAMPADINA/BULB	INFO
	F3.048 BIANCO/NERO WHITE/BLACK	2.849,00	3.475,78	 E27 MAX 7x100W	PESO/WEIGHT 35,0 kg 77,17 lbs IMBALLO/BOX (cm) box ¹ 80x80x20 box ² 65x26x18 box ³ 65x26x18 box ⁴ 65x26x18 VOLUME/VOLUME 0,219 m ³ CLASSE ENERGETICA ENERGY EFFICIENCY CLASS A ⁺ - E ALIMENTAZIONE POWER SUPPLY 230V 50/60Hz
		F3.048 MULTICOLORE MULTICOLOUR	2.849,00	3.475,78	
	Composizione vetri: 72 bianchi / 72 neri Glass composition: 72 white / 72 black				

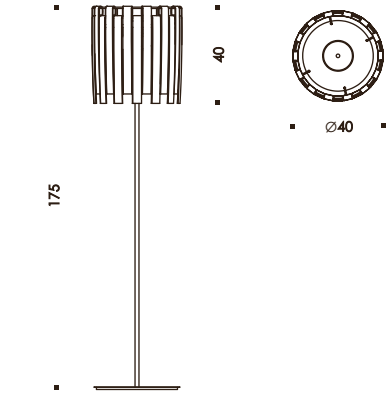
Pi.Kà TERRA / FLOOR LAMP

	CODICE/CODE	€	€+IVA	LAMPADINA/BULB	INFO
	F2.002 BIANCO/NERO WHITE/BLACK	896,00	1.093,12	 E27 MAX 3x100W	PESO/WEIGHT 25,0 kg 55,12 lbs IMBALLO/BOX (cm) box ¹ 50x65x40 box ² 42x42x172 VOLUME/VOLUME 0,433 m ³ CLASSE ENERGETICA ENERGY EFFICIENCY CLASS C - E ALIMENTAZIONE POWER SUPPLY 230V 50/60Hz + DIMMERABLE LIGHT
	F2.003 MULTICOLORE MULTICOLOUR	896,00	1.093,12		
	Composizione vetri: 16 bianchi / 16 neri 32 multicolore Glass composition: 16 white / 16 black 32 multicolour				

RAPÀLA

Lampada a sospensione con emissione di luce diretta. Diffusore in vetro opalino bianco lucido, nero lucido, verde lucido, arancio lucido, rosso lucido. Struttura in metallo con finitura cromo.

Lamp with emission of direct lighting. Glass diffuser in the models of gloss white, gloss black, gloss green, gloss orange, gloss red. Structure in metal with pearlescent chrome.

RAPÀLA SOSPENSIONE / HANGING LAMP

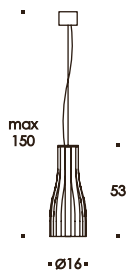

CODICE/CODE	€	€+IVA	LAMPADINA/BULB	INFO
F1.011 BIANCO LUCIDO GLOSS WHITE	285,00	347,70	E27 SPOT HALOGEN MAX 1x50W	CE IP20 PESO/WEIGHT 1,5 kg 3,31 lbs IMBALLO/BOX (cm) 25x25x60 VOLUME/VOLUME 0,037 m³ CLASSE ENERGETICA ENERGY EFFICIENCY CLASS A+ - E ALIMENTAZIONE POWER SUPPLY 230V 50/60Hz
F1.012 NERO LUCIDO GLOSS BLACK	285,00	347,70		
F1.013 VERDE LUCIDO GLOSS GREEN	285,00	347,70	E27 energy saving MAX 1x23W	
F1.014 ARANCIO LUCIDO GLOSS ORANGE	285,00	347,70		
F1.015 ROSSO LUCIDO GLOSS RED	285,00	347,70	E27 LED SPOT MAX 1x7W	

SKIN

Lampada ad emissione di luce indiretta. Frontale in metallo bianco lucido, nero lucido, oppure rivestito in vera pelle, shearling riccio o liscio. Struttura in metallo con finitura bianco o nero.

Wall lamp with fitting that provides indirect light. Front in glossy white or black metal, or covered in real leather, curly or smooth shearling. Metal structure with white or black finish.

SKIN PARETE / WALL LAMP

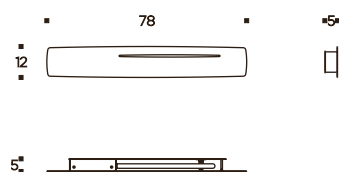

CODICE/CODE	€	€+IVA	LAMPADINA/BULB	INFO
F3.059 BIANCO LUCIDO GLOSS WHITE	395,00	481,90	2G11 1x36W	CE IP20 PESO/WEIGHT 5,5 kg 12,13 lbs IMBALLO/BOX (cm) 90x90x13 VOLUME/VOLUME 0,105 m³ CLASSE ENERGETICA ENERGY EFFICIENCY CLASS A ALIMENTAZIONE POWER SUPPLY 230V 50/60Hz
F3.060 NERO LUCIDO GLOSS BLACK	395,00	481,90		
F3.061 PELLE* LEATHER	580,00	707,60		
F3.062 SHEARLING RICCIO BIANCO# WHITE CURLY SHEARLING	580,00	707,60		
F3.063 SHEARLING LISCIO NERO* BLACK SMOOTH SHEARLING	580,00	707,60		

* STRUTTURA NERO LUCIDO
STRUCTURE BLACK GLOSS

STRUTTURA BIANCO LUCIDO
STRUCTURE WHITE GLOSS

SPARTA

Lampada ad emissione di luce indiretta. Vetro opalino bianco satinato. Struttura in metallo con finitura cromo satinato.

Lamp with emission of indirect lighting with diffuser in satin opaline glass. Frame finishing in satin chrome.

SPARTA SOSPENSIONE / HANGING LAMP

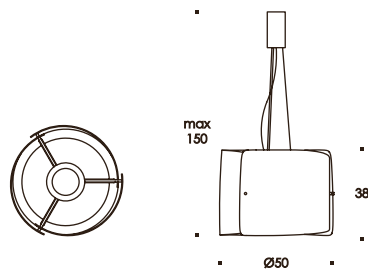

F1.010 BIANCO SATINATO
SATIN WHITE

€ **520,00**

€+IVA **634,40**

 E27 ALOGENA
MAX 1x250W

 E27 GLOBE
MAX 1x150W

 E27 energy saving
MAX 1x33W



PESO/WEIGHT
7,0 kg
15,43 lbs

IMBALLO/BOX (cm)
55x55x35

VOLUME/VOLUME
0,106 m³

CLASSE ENERGETICA
ENERGY EFFICIENCY CLASS
A⁺ - E

ALIMENTAZIONE
POWER SUPPLY
230V 50/60Hz

SPARTA TERRA / FLOOR

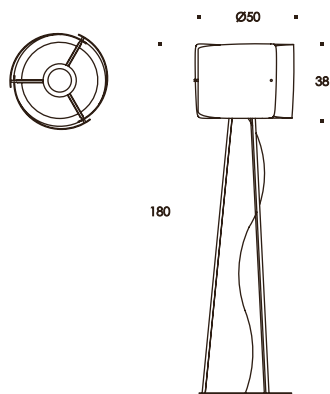

F2.001 BIANCO SATINATO
SATIN WHITE

€ **690,00**

€+IVA **841,80**

 E27 ALOGENA
MAX 1x250W

 E27 GLOBE
MAX 1x150W



PESO/WEIGHT
11,0 kg
24,2 lbs

IMBALLO/BOX (cm)
55x55x35
15x15x160

VOLUME/VOLUME
0,142 m³

CLASSE ENERGETICA
ENERGY EFFICIENCY CLASS
C - E

ALIMENTAZIONE
POWER SUPPLY
230V 50/60Hz
DIMMERABLE
LIGHT

STAR

Lampada a luce indiretta. Vetro bianco ceramicato oppure nero lucido. Struttura in metallo con finitura cromo. Doppia fonte luminosa indipendente.

Lamp with indirect light. Ceramic polished white or polished black glass. Metal structure with chrome finishing. Double independent light sources.

STAR 50 SOFFITTO / CEILING

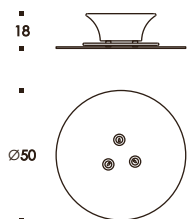

CODICE/CODE

€

€+IVA

LAMPADINA/BULB

INFO

F3.038 BIANCO CERAMICATO
CERAMIC WHITE

509,00

620,98



CE

PESO/WEIGHT
8,0 kg
17,64 lbs

F3.039 NERO
BLACK

509,00

620,98



IMBALLO/BOX (cm)
66x66x32

dimmerabile/dimmable
F3.038/D BIANCO CERAMICATO
CERAMIC WHITE

509,00

620,98



VOLUME/VOLUME
0,139 m³

F3.039/D NERO
BLACK

509,00

620,98

CLASSE ENERGETICA
ENERGY EFFICIENCY CLASS
A⁺ - C

ALIMENTAZIONE
POWER SUPPLY
230V 50/60Hz

STAR 60 SOFFITTO / CEILING

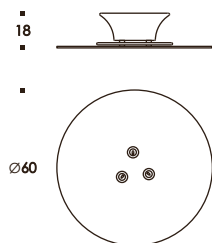

CODICE/CODE

€

€+IVA

LAMPADINA/BULB

INFO

F3.040 BIANCO CERAMICATO
CERAMIC WHITE

530,00

646,60



CE

PESO/WEIGHT
8,5 kg
18,74 lbs

F3.041 NERO
BLACK

530,00

646,60



IMBALLO/BOX (cm)
66x66x32

dimmerabile/dimmable
F3.040/D BIANCO CERAMICATO
CERAMIC WHITE

530,00

646,60



VOLUME/VOLUME
0,139 m³

F3.041/D NERO
BLACK

530,00

646,60

CLASSE ENERGETICA
ENERGY EFFICIENCY CLASS
A⁺ - C

ALIMENTAZIONE
POWER SUPPLY
230V 50/60Hz

Codice Code	Denominazione Denomination	Codice Code	Denominazione Denomination
F1.001	ARC SOSPENSIONE VETRO TEMPERATO	F3.009/B	CIRCLE C3 SOFF/PARETE NERO LUCIDO VETRI SATINATI
F1.001	ARC SOSPENSIONE VETRO TEMPERATO	F3.010/A	CIRCLE C4 SOFF/PARETE CROMO PERLATO VETRI TRASP.
F1.002	LINE SOSPENSIONE SMALL VETRO TEMPERATO	F3.010/B	CIRCLE C4 SOFF/PARETE CROMO PERLATO VETRI SATINATI
F1.003	LINE SOSPENSIONE MAX VETRO TEMPERATO	F3.011/A	CIRCLE C4 SOFF/PARETE BIANCO LUCIDO VETRI TRASP.
F1.004	NICE 80 SOSPENSIONE BIANCO/BIANCO/BIANCO	F3.011/B	CIRCLE C4 SOFF/PARETE BIANCO LUCIDO VETRI SATINATI
F1.005	NICE 80 SOSPENSIONE VIOLA/VIOLA/VIOLA	F3.012/A	CIRCLE C4 SOFF/PARETE NERO LUCIDO VETRI TRASP.
F1.006	NICE 80 SOSPENSIONE BIANCO/BIANCO/GRIGIO	F3.012/B	CIRCLE C4 SOFF/PARETE NERO LUCIDO VETRI SATINATI
F1.007	NICE 80 SOSPENSIONE BIANCO/BIANCO/ARANCIO	F3.013/A	CIRCLE C6 SOFF/PARETE CROMO PERLATO VETRI TRASP.
F1.008	NICE 80 SOSPENSIONE BIANCO/BIANCO/VERDE	F3.013/B	CIRCLE C6 SOFF/PARETE CROMO PERLATO VETRI SATINATI
F1.009	NICE 80 SOSPENSIONE BIANCO/BIANCO/VIOLA	F3.014/A	CIRCLE C6 SOFF/PARETE BIANCO LUCIDO VETRI TRASP.
F1.010	SPARTA SOSPENSIONE BIANCO SATINATO	F3.014/B	CIRCLE C6 SOFF/PARETE BIANCO LUCIDO VETRI SATINATI
F1.011	RAPÀLA SOSPENSIONE BIANCO LUCIDO	F3.015/A	CIRCLE C6 SOFF/PARETE NERO LUCIDO VETRI TRASP.
F1.012	RAPÀLA SOSPENSIONE NERO LUCIDO	F3.015/B	CIRCLE C6 SOFF/PARETE NERO LUCIDO VETRI SATINATI
F1.013	RAPÀLA SOSPENSIONE VERDE LUCIDO	F3.016/A	CIRCLE L3 PARETE CROMO PERLATO VETRI TRASPARENTI
F1.014	RAPÀLA SOSPENSIONE ARANCIO LUCIDO	F3.016/B	CIRCLE L3 PARETE CROMO PERLATO VETRI SATINATI
F1.015	RAPÀLA SOSPENSIONE ROSSO LUCIDO	F3.017/A	CIRCLE L3 PARETE BIANCO LUCIDO VETRI TRASPARENTI
F1.016	ARC SOSPENSIONE VETRO TEMPERATO DIMMERABILE	F3.017/B	CIRCLE L3 PARETE BIANCO LUCIDO VETRI SATINATI
F1.017	LINE SOSPENSIONE SMALL VETRO TEMPERATO DIM.	F3.018/A	CIRCLE L3 PARETE NERO LUCIDO VETRI TRASPARENTI
F1.018	LINE SOSPENSIONE MAX VETRO TEMPERATO DIMMERABILE	F3.018/B	CIRCLE L3 PARETE NERO LUCIDO VETRI SATINATI
F1.019	PI.KÀ 40 SOSPENSIONE BIANCO-NERO	F3.019/A	CIRCLE L5 PARETE CROMO PERLATO VETRI TRASPARENTI
F1.020	PI.KÀ 40 SOSPENSIONE MULTICOLORE	F3.019/B	CIRCLE L5 PARETE CROMO PERLATO VETRI SATINATI
F1.021	PI.KÀ 60 SOSPENSIONE BIANCO-NERO	F3.020/A	CIRCLE L5 PARETE BIANCO LUCIDO VETRI TRASPARENTI
F1.022	PI.KÀ 60 SOSPENSIONE MULTICOLORE	F3.020/B	CIRCLE L5 PARETE BIANCO LUCIDO VETRI SATINATI
F1.023	PI.KÀ 80 SOSPENSIONE BIANCO-NERO	F3.021/A	CIRCLE L5 PARETE NERO LUCIDO VETRI TRASPARENTI
F1.024	PI.KÀ 80 SOSPENSIONE MULTICOLORE	F3.021/B	CIRCLE L5 PARETE NERO LUCIDO VETRI SATINATI
F1.025	FREE/35 SOSPENSIONE BIANCO OPACO	F3.022/A	CIRCLE L9 PARETE CROMO PERLATO VETRI TRASPARENTI
F1.026	FREE/35 SOSPENSIONE MOKA OPACO	F3.022/B	CIRCLE L9 PARETE CROMO PERLATO VETRI SATINATI
F1.027	FREE/35 SOSPENSIONE ROSSO OPACO	F3.023/A	CIRCLE L9 PARETE BIANCO LUCIDO VETRI TRASPARENTI
F1.028	FREE/35 SOSPENSIONE FOGLIA ORO	F3.023/B	CIRCLE L9 PARETE BIANCO LUCIDO VETRI SATINATI
F1.029	FREE/60 SOSPENSIONE BIANCO OPACO	F3.024/A	CIRCLE L9 PARETE NERO LUCIDO VETRI SATINATI
F1.030	FREE/60 SOSPENSIONE MOKA OPACO	F3.025	NICE 80 SOFFITTO/PARETE BIANCO/BIANCO/BIANCO
F1.031	FREE/60 SOSPENSIONE ROSSO OPACO	F3.026	NICE 80 SOFFITTO/PARETE VIOLA/VIOLA/VIOLA
F1.032	FREE/60 SOSPENSIONE FOGLIA ORO	F3.027	NICE 80 SOFFITTO/PARETE BIANCO/BIANCO/GRIGIO
F1.033	FREE/80 SOSPENSIONE BIANCO OPACO	F3.028	NICE 80 SOFFITTO/PARETE BIANCO/BIANCO/ARANCIO
F1.034	FREE/80 SOSPENSIONE MOKA OPACO	F3.029	NICE 80 SOFFITTO/PARETE BIANCO/BIANCO/VERDE
F1.035	FREE/80 SOSPENSIONE ROSSO OPACO	F3.030	NICE 80 SOFFITTO/PARETE BIANCO/BIANCO/VIOLA
F1.036	FREE/80 SOSPENSIONE FOGLIA ORO	F3.031	EOLO SOFFITTO/PARETE SMALL BIANCO SATINATO
F1.037	FREE/100 SOSPENSIONE BIANCO OPACO	F3.032	EOLO SOFFITTO/PARETE MAX BIANCO SATINATO
F1.038	FREE/100 SOSPENSIONE MOKA OPACO	F3.033/A	CIRCLE R9 SOFF/PARETE CROMO PERLATO VETRI TRASP.
F1.039	FREE/100 SOSPENSIONE ROSSO OPACO	F3.033/B	CIRCLE R9 SOFF/PARETE CROMO PERLATO VETRI SATINATI
F1.040	FREE/100 SOSPENSIONE FOGLIA ORO	F3.034/A	CIRCLE R9 SOFF/PARETE BIANCO LUCIDO VETRI TRASP.
F1.041	FREE KIT INCASSO BIANCO OPACO	F3.034/B	CIRCLE R9 SOFF/PARETE BIANCO LUCIDO VETRI SATINATI
F1.042	FREE KIT INCASSO MOKA OPACO	F3.035/A	CIRCLE R9 SOFFITTO/PARETE NERO LUCIDO VETRI TRASP.
F1.043	FREE KIT INCASSO ROSSO OPACO	F3.035/B	CIRCLE R9 SOFFITTO/PARETE NERO LUCIDO VETRI SATINATI
F1.044	FREE KIT INCASSO FOGLIA ORO	F3.036	ARC PARETE MAX VETRO TEMPERATO CON DIMMER
F1.045	FREE X2 /60 SOSPENSIONE BIANCO OPACO	F3.037	LINE/165 PARETE VETRO TEMPERATO CON DIMMER
F1.046	FREE X2 /60 SOSPENSIONE MOKA OPACO	F3.038	STAR 50 SOFFITTO BIANCO
F1.047	FREE X2 /60 SOSPENSIONE ROSSO OPACO	F3.038/D	STAR 50 SOFFITTO BIANCO CON DIMMER
F1.048	FREE X2 /60 SOSPENSIONE FOGLIA ORO	F3.039	STAR 50 SOFFITTO NERO
F1.049	FREE X2 /80 SOSPENSIONE BIANCO OPACO	F3.039/D	STAR 50 SOFFITTO NERO CON DIMMER
F1.050	FREE X2 /80 SOSPENSIONE MOKA OPACO	F3.040	STAR 60 SOFFITTO BIANCO
F1.051	FREE X2 /80 SOSPENSIONE ROSSO OPACO	F3.040/D	STAR 60 SOFFITTO BIANCO CON DIMMER
F1.052	FREE X2 /80 SOSPENSIONE FOGLIA ORO	F3.041	STAR 60 SOFFITTO NERO
F1.053	FREE X2 /100 SOSPENSIONE BIANCO OPACO	F3.041/D	STAR 60 SOFFITTO NERO CON DIMMER
F1.054	FREE X2 /100 SOSPENSIONE MOKA OPACO	F3.042	PI.KÀ 40 SOFFITTO BIANCO-NERO
F1.055	FREE X2 /100 SOSPENSIONE ROSSO OPACO	F3.043	PI.KÀ 40 SOFFITTO MULTICOLORE
F1.056	FREE X2 /100 SOSPENSIONE FOGLIA ORO	F3.044	PI.KÀ 60 SOFFITTO BIANCO-NERO
F1.057	FREE X3 /80 SOSPENSIONE BIANCO OPACO	F3.045	PI.KÀ 60 SOFFITTO MULTICOLORE
F1.058	FREE X3 /80 SOSPENSIONE MOKA OPACO	F3.046	PI.KÀ 80 SOFFITTO BIANCO-NERO
F1.059	FREE X3 /80 SOSPENSIONE ROSSO OPACO	F3.047	PI.KÀ 80 SOFFITTO MULTICOLORE
F1.060	FREE X3 /80 SOSPENSIONE FOGLIA ORO	F3.048	PI.KÀ 800 SOFFITTO BIANCO-NERO
F1.061	FREE X3 /100 SOSPENSIONE BIANCO OPACO	F3.049	GAME PARETE BIANCO OPACO
F1.062	FREE X3 /100 SOSPENSIONE MOKA OPACO	F3.053	GAME PARETE MOKA OPACO
F1.063	FREE X3 /100 SOSPENSIONE ROSSO OPACO	F3.055	EXA MAX PARETE BIANCO
F1.064	FREE X3 /100 SOSPENSIONE FOGLIA ORO	F3.056	EXA MAX PARETE NERO
F2.001	SPARTA TERRA BIANCO SATINATO	F3.057	EXA SMALL PARETE BIANCO
F2.002	PI.KÀ TERRA BIANCO-NERO	F3.058	EXA SMALL PARETE NERO
F2.003	PI.KÀ TERRA MULTICOLORE	F3.059	SKIN PARETE BIANCO
F3.001	ARC PARETE SMALL VETRO TEMPERATO	F3.060	SKIN PARETE NERO
F3.002	ARC PARETE MAX VETRO TEMPERATO	F3.061	SKIN PARETE PELLE NATURALE
F3.003	LINE/55 PARETE VETRO TEMPERATO	F3.062	SKIN PARETE SCHEARLING RICCIO BIANCO
F3.004	LINE/75 PARETE VETRO TEMPERATO	F3.063	SKIN PARETE SCHEARLING LISCIO NERO
F3.005	LINE/115 PARETE VETRO TEMPERATO	F4.001	LITTLE GAME TAVOLO BIANCO OPACO
F3.006	LINE/165 PARETE VETRO TEMPERATO	F4.002	LITTLE GAME TAVOLO BIANCO LUCIDO
F3.007/A	CIRCLE C3 SOFF/PARETE CROMO PERLATO VETRI TRASP.	F4.003	LITTLE GAME TAVOLO NERO OPACO
F3.007/B	CIRCLE C3 SOFF/PARETE CROMO PERLATO VETRI SATINATI	F4.004	LITTLE GAME TAVOLO NERO LUCIDO
F3.008/A	CIRCLE C3 SOFF/PARETE BIANCO LUCIDO VETRI TRASP.	F4.005	LITTLE GAME TAVOLO ROSSO OPACO
F3.008/B	CIRCLE C3 SOFF/PARETE BIANCO LUCIDO VETRI SATINATI	F4.006	LITTLE GAME TAVOLO ROSSO LUCIDO
F3.009/A	CIRCLE C3 SOFF/PARETE NERO LUCIDO VETRI TRASP.	F4.007	LITTLE GAME TAVOLO VERDE ZOLFO OPACO
		F4.008	LITTLE GAME TAVOLO VERDE ZOLFO LUCIDOO

Codice Code	Denominazione Denomination	Codice Code	Denominazione Denomination
F4.009	LITTLE GAME TAVOLO MOKA OPACO		
F4.010	LITTLE GAME TAVOLO MOKA LUCIDO		
F4.011	GAME TAVOLO BIANCO OPACO		
F4.012	GAME TAVOLO BIANCO LUCIDO		
F4.019	GAME TAVOLO MOKA OPACO		
F4.020	GAME TAVOLO MOKA LUCIDO		
T1.001	KIT SOSPENSIONE KB		
T1.002	ALOHA SOSPENSIONE		
T1.020	KB SFERA SMALL SOSP MULTICOLORE		
T1.021	KB SFERA SMALL SOSP BIANCO		
T1.022	KB SFERA MAX SOSP MULTICOLORE		
T1.023	KB SFERA MAX SOSP BIANCO		
T2.015	KB SFERA TERRA MULTICOLORE		
T2.016	KB SFERA TERRA BIANCO		
T3.017	KB 130 SOFF/PAR MULTICOLORE		
T3.018	KB 130 SOFF/PAR BIANCO		
T3.019	KB 100 SOFF/PAR MULTICOLORE		
T3.020	KB 100 SOFF/PAR BIANCO		
T3.021	KB 80 SOFF/PAR MULTICOLORE		
T3.022	KB 80 SOFF/PAR BIANCO		
T3.023	ALOHA PARETE		
T3.039	KB LINEARE SOFF/PAR MULTICOLORE		
T3.040	KB LINEARE SOFF/PAR BIANCO		
T3.041	KB QUADRO SOFF/PAR SMALL		
T3.042	KB QUADRO MAX SOFF/PAR MULTICOLORE		
T3.043	KB QUADRO MAX SOFF/PAR BIANCO		
T3.070	KB SFERA SMALL SOFF/PAR MULTICOLORE		
T3.071	KB SFERA SMALL SOFF/PAR BIANCO		
T3.072	KB SFERA MAX SOFF/PAR MULTICOLORE		
T3.073	KB SFERA MAX SOFF/PAR BIANCO		
T3.085	KB QUADRO SOFF/PAR MULTICOLORE		
T4.005	KB SFERA TAVOLO MULTICOLORE		
T4.006	KB SFERA TAVOLO BIANCO		

Condizioni di vendita

PREZZI

Le condizioni sono quelle in vigore alla data dell'ordine ed il prezzo s'intende franco nostro magazzino. I prezzi indicati sono espressi in Euro (IVA esclusa).

MERCE

La merce è attentamente selezionata e accuratamente imballata prima della spedizione. Imballo standard compreso nel prezzo, escluso lampadine.

CONSEGNE

Il termine di consegna è da considerarsi indicativo, i Vostri ordini e le nostre offerte si intendono "salvo disponibilità di magazzino". Eventuali ritardi non annullano la validità degli ordini e non potranno essere invocati per risarcimento o altro.

RECLAMI

Articoli mancanti o rotti devono essere immediatamente segnalati allo spedizioniere o tramite comunicazione scritta alla FlorianLight, entro un massimo di 8 giorni dal ricevimento della merce.

RESI

L'azienda non accetta resi se non preventivamente autorizzati per iscritto.

PAGAMENTO

I pagamenti devono essere effettuati nei termini e nelle condizioni stabilite direttamente alla nostra sede. Il pagamento puntuale è condizione indispensabile per l'accettazione di eventuali reclami. In ogni caso di ritardo dei pagamenti, la venditrice si riserva di addebitare gli interessi di mora, sulla base del tasso di sconto ufficiale maggiorato di 5 punti percentuali.

GIURISDIZIONE

Per qualsiasi controversia è competente il foro di Treviso.

MODIFICHE E MIGLIORIE DEL PRODOTTO

Il venditore si riserva, senza preavviso, di apportare ai suoi prodotti tutte le modifiche necessarie al miglioramento degli stessi.

Modelli depositati, non possono essere pubblicati o riprodotti senza nostra autorizzazione scritta.

Sales terms and conditions

PRICES

The prices are a SRP (suggested retail price) ex-works basis. The prices are expressed in Euro.

GOODS

Goods are carefully selected and packaged before being sent. Standard packaging included in the price, any kind of bulb isn't included.

DELIVERY

Any dates quoted for delivery of the goods are approximate, your orders and our offers must be considered subjected to availability of stock. The seller shall not be liable for any delay in delivery of the goods howsoever caused. Any delivery time shall be not be binding.

RECLAMI

All the goods have to be insured by the client during the transport. Any broken or missing item has to be immediately claimed to the forwarder or to FlorianLight in writing, within a maximum of 8 days from the date of receipt.

RETURNS

The company doesn't accept any returns unless previously authorization by the seller in writing.

PAYMENT

Payments must be made in terms and conditions directly to our company. In case of claim, the buyer has to pay on the due date, as a necessary condition to accept any claim. If the buyer fails to pay on the due date, the seller shall be entitled to charge the buyer interest on the amount unpaid increased by 5% until payment in full is made.

LAWS

Any contestation falls within the cognizance of the Treviso Law-court and shall be governed by the Italian law.

PRODUCT DETAILS

The seller reserves the rights without pre-notice to introduce any changes in the specification of the goods to improve them.

Models have been patented, they can't be posted or copied without our authorization in writing.

WWW.FLORIANLIGHT.COM