

Lival Mini-Master





dynamic light



quality



environment



health-safety



social accountability



P.O.Box 31 04131 SIPOO Finland
Tel: +358 - 9 - 235 511
Fax: +358 - 9 - 239 3007, 239 2335
www.lival.com / lival@lival.com



MOTOR HARLEY-DAVIDSON CYCLES SERVICE
HOWARD W. BELMONT, OWNER
HARLEY-DAVIDSON, ST. PAUL, CO.
217 W. 11TH ST., ST. PAUL, MINN.

HOUSE OF BIKES
MYTY
HARLEY-DAVIDSON

dynamic light

pendel	
Jumbo	7
Optic	8
Magic	9

spot / flood	
Premium Slim	11
Premium Axial	12
Premium Fighter	13
Premium Fighter Axial	14
Premium Vertical	15
Premium Horizon	16
Premium Slim Par 20	17
Premium Slim Par 30	18
Premium Halogen	19
Mini-Master	21

DL	
Lival Mini-Master DL	22

spot / flood	
Shop-Master	23
Shop-Master CDM-RIII	24
Titium	25
Cyli-con	26
Hawk	27
Exus	29

DL	
Hexus B / Hexus	30
Function DL E HF	32
Function DL	33
Function DL Par 20	34
Function DL Par 30	35
Mond E HF	36
Mond CDM	37

Mond SDW	38
Super DL E HF	39
Super DL	40
Form	41
Form Kvadrat	42
Form Duo	43
Form Trio	44
Form Quattro	45
Pistol DL	46

spot / flood	
Pistol	47
Pistol Halogen	48
Pistol CDM-RIII	49

DL	
Power DL	50

powergears	51
classics	53
light sources	54
faceted reflectors	55

DL	
Hony	57
Mony	58

elektro	
Partout	60
Partout II	61
Mamy	62
Sunny	62
Circus	63
Globus	63
Practical	64

trac	66
-------------	----

Pendel



dynamic light



Jumbo HF / K

816

480 100W
530 100W

406

IP20
CL I/II
G12
PG12-I
GX24q
E27
E40

* = 5

6

9

40 / pall

Dulux T/E IN PL-H CDM-T SDW-TG SDW-T HQI-E
HQI-E/P

T/E IN 2x32 HF	T/E IN 2x42 HF	R SDW-TG 100 HF	PL-H 60/830 HF	PL-H 85/830 HF	PL-H 120/830 HF
I394223*	I394423*	I39677*0	I39A111*	I39A131*	I39A151*
3100g	3230g	3876g	3154g	3188g	3486g
cd / 1000lm	cd / 1000lm	cd / 1000lm	cd / 1000lm	cd / 1000lm	cd / 1000lm
R CDM-T 70 K	R CDM-T 150 K	R SDW-T 100 K	HQI-E 150 K	HQI-E/P 250 K	
I39476*0	I39526*0	I39821*0	I39521*0	I39721*0	
4790g	5630g	4500g	5600g	6690g	
cd / 1000lm	cd / 1000lm	cd / 1000lm	cd / 1000lm	cd / 1000lm	



CDM-T		
SP	I9980016	
FL	I9980026	
WFL		I9980036
SDW-T		
SP	I9989111	
FL	I9989112	
WFL	I9989113	
CDM-T		
SP	I9980046	
FL	I9980056	
WFL		I9980066
SDW-T		
SP	I9989121	
FL	I9989122	
WFL	I9989123	



Optic HF / K

812

816

IP20
 CL II
 G12
 PG12-1
 GX24q
 E27

* = 5 6 9

Dulux D/E

Dulux T/E IN

CDM-T

SDW-T

HQI-E

40 / pall

812 D/E 2x26 HF I40I23*0 I9I0g cd / I000lm 	812 R CDM-T 70 K I40492*0 3220g cd / I000lm FL 22 	812 HQI-E 70 K I4047I*0 3I90g cd / I000lm
--	--	---

812 T/E IN 2x32 HF I40223*0 I950g cd / I000lm 	812 R SDW-T I00 K I4053I*0 3220g cd / I000lm FL 23 	812 HQI-E I00 K I4062I*0 3230g cd / I000lm
---	---	--



CDM-T	
SP I99800I6	
FL I9980026	
WFL I9980036	
SDW-T	
SP I9989I1I	
FL I9989I12	
WFL I9989I13	

CDM-T	
SP I9980046	
FL I9980056	
WFL I9980066	
SDW-T	
SP I9989I2I	
FL I9989I22	
WFL I9989I23	



Magic 816

Magic

HF Dulux D/E 26, Dulux T/E IN 32-42, PL-H 60-85-120
 HF CDM-T, HCI-T, HQI-T 35-70, SDW-TG 50-100
 HF HQI-E 70, HCI-E/P 70

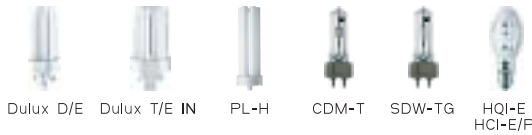
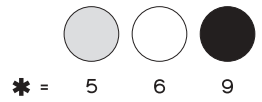
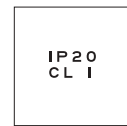
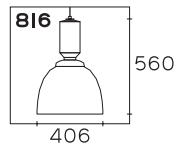
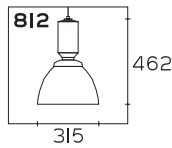

40 / pall

816	816	816
D/E 2x26/840 HF	T/E 2x32/840 HF	T/E 2x42/840 HF
I42E10I*	I42E40I*	I42E70I*
2161g	2205g	2231g
cd / 1000lm	cd / 1000lm	cd / 1000lm

816	816	816
PL-H 60/830 HF	PL-H 85/830 HF	PL-H 120/830 HF
I42G10I*	I42G30I*	I42G50I*
2268g	2302g	2342g
cd / 1000lm	cd / 1000lm	cd / 1000lm

816	816	816
CDM-T 70 HF	SDW-TG 100 HF	HQI-E 70 HF
I42236I*	I42A26I*	I42810I*
2232g	2809g	2428g
cd / 1000lm	cd / 1000lm	cd / 1000lm
FLf 24° 	FLf 23° 	



Magic 816



Magic 812

Available in various colours...

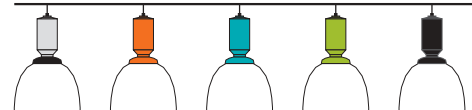

spot / flood



dynamic light



Premium Slim HF CDM-T 35-70 / SDW-TG 50-100

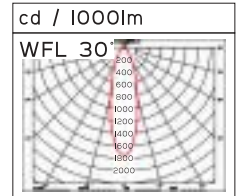
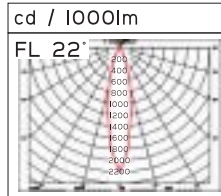
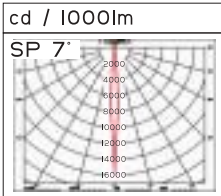
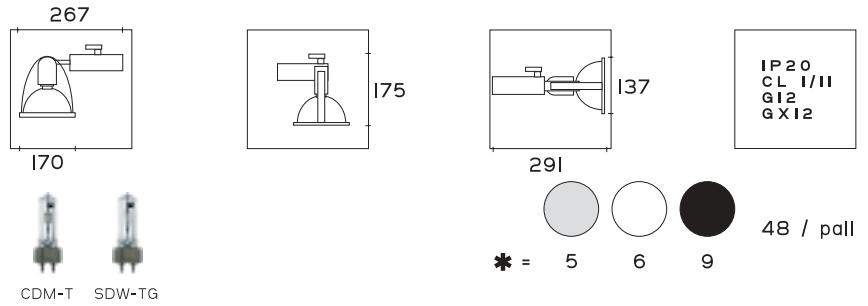

SP 7°	FL 22°	WFL 30°
CDM-T 35 HF	CDM-T 35 HF	CDM-T 35 HF
I870I15*	I870I25*	I870I35*
860g	860g	860g

SP 7°	FL 22°	WFL 30°
CDM-T 70 HF	CDM-T 70 HF	CDM-T 70 HF
I8705I5*	I870525*	I870535*
920g	920g	920g

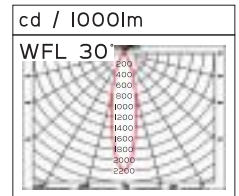
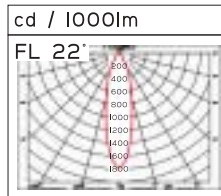
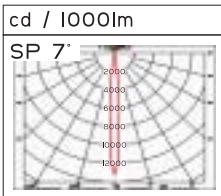

SP 7°	FL 22°	WFL 30°
SDW-TG 50 HF	SDW-TG 50 HF	SDW-TG 50 HF
I87I4I1*	I87I42I*	I87I43I*
I3I0g	I3I0g	I3I0g

SP 7°	FL 22°	WFL 30°
SDW-TG 100 HF	SDW-TG 100 HF	SDW-TG 100 HF
I87I5I1*	I87I52I*	I87I53I*
I3I0g	I3I0g	I3I0g



SP	I983I120	
FL	I983I130	
WFL	I983I140	

SP	I983I170	
FL	I983I180	
WFL	I983I190	

○	I9937I05
○	I9937I06
●	I9937I09



Premium Axial HF CDM-T 35-70

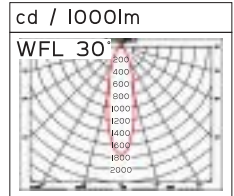
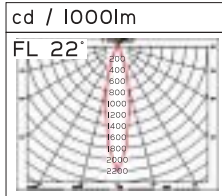
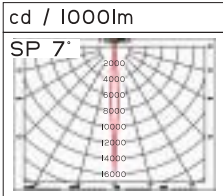
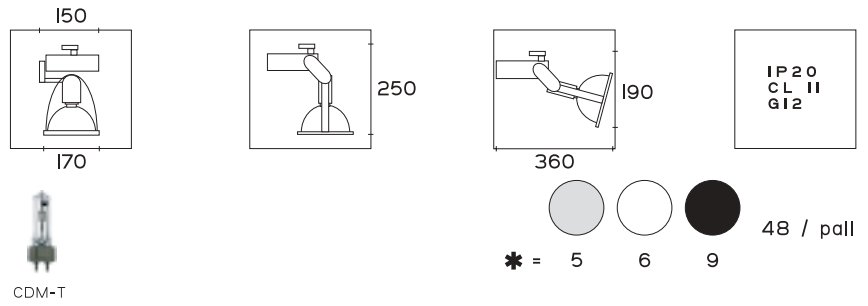

SP 7°	FL 22°	WFL 30°	SP 7°	FL 22°	WFL 30°
CDM-T 35 HF	CDM-T 35 HF	CDM-T 35 HF	CDM-T 70 HF	CDM-T 70 HF	CDM-T 70 HF
1874515*	1874525*	1874535*	1875515*	1875525*	1875535*
910g	910g	910g	970g	970g	970g



SP	19831120	
FL	19831130	
WFL	19831140	

SP	19831170	
FL	19831180	
WFL	19831190	

	19937105
	19937106
	19937109



Premium Fighter HF / K CDM-T 35-70

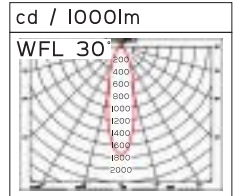
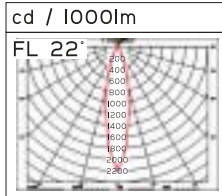
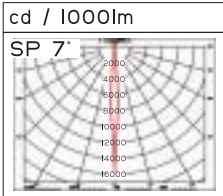
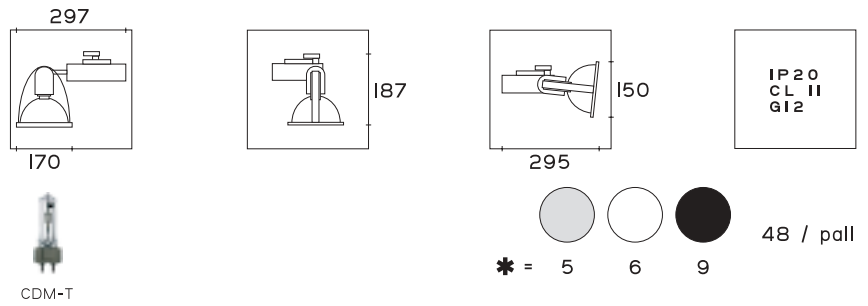

SP 7°	
CDM-T 35 HF	CDM-T 35 K
I930115*	I932015*
900g	1770g

FL 22°	
CDM-T 35 HF	CDM-T 35 K
I930125*	I932025*
900g	1770g

WFL 30°	
CDM-T 35 HF	CDM-T 35 K
I930135*	I932035*
900g	1770g

CDM-T 70 HF		CDM-T 70 K	
I930515*	I932515*		
960g	2100g		

CDM-T 70 HF		CDM-T 70 K	
I930525*	I932525*		
960g	2100g		

CDM-T 70 HF		CDM-T 70 K	
I930535*	I932535*		
960g	2100g		



SP	I9831120
FL	I9831130
WFL	I9831140



SP	I9831170
FL	I9831180
WFL	I9831190



○	I9937105
○	I9937106
●	I9937109





Premium Fighter Axial **HF** / K CDM-T 35-70

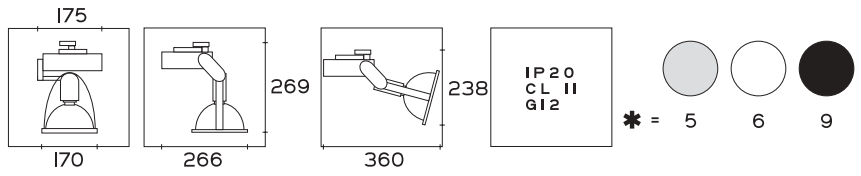

CDM-T

48 / pall

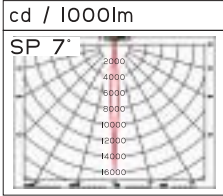

SP 7°	
CDM-T 35 HF	CDM-T 35 K
I930315*	I935115*
950g	2090g

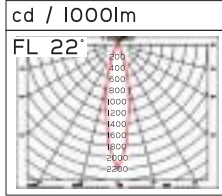

FL 22°	
CDM-T 35 HF	CDM-T 35 K
I930325*	I935125*
950g	2090g

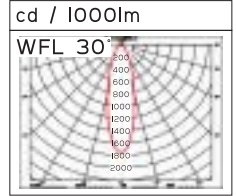

WFL 30°	
CDM-T 35 HF	CDM-T 35 K
I930335*	I935135*
950g	2090g

CDM-T 70 HF	CDM-T 70 K
I930715*	I935515*
1010g	2150g

CDM-T 70 HF	CDM-T 70 K
I930725*	I935525*
1010g	2150g

CDM-T 70 HF	CDM-T 70 K
I930735*	I935535*
1010g	2150g



SP	I9831120
FL	I9831130
WFL	I9831140



SP	I9831170
FL	I9831180
WFL	I9831190



	I9937105
	I9937106
	I9937109





Premium Vertical HF CDM-T 35-70 / SDW-TG 50-100

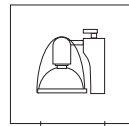

225



CDM-T SDW-TG

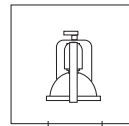

130

198

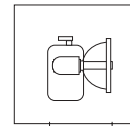

185

182

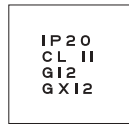

IP20
CL II
G12
GX12

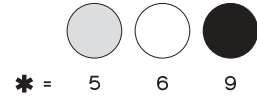

* = 5 6 9

60 / pall

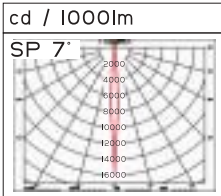

SP 7°	FL 22°	WFL 30°
CDM-T 35 HF	CDM-T 35 HF	CDM-T 35 HF
I877515*	I877525*	I877535*
860g	860g	860g

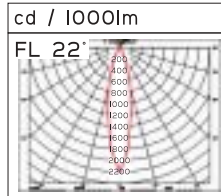

SP 7°	FL 22°	WFL 30°
CDM-T 70 HF	CDM-T 70 HF	CDM-T 70 HF
I878515*	I878525*	I878535*
920g	920g	920g

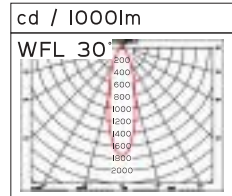

SP 7°	FL 22°	WFL 30°
SDW-TG 50 HF	SDW-TG 50 HF	SDW-TG 50 HF
I879711*	I879721*	I879731*
I310g	I310g	I310g

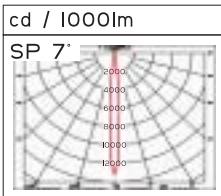

SP 7°	FL 22°	WFL 30°
SDW-TG 100 HF	SDW-TG 100 HF	SDW-TG 100 HF
I879911*	I879921*	I879931*
I310g	I310g	I310g

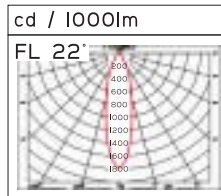

SP 7°	FL 22°	WFL 30°
SDW-TG 100 HF	SDW-TG 100 HF	SDW-TG 100 HF
I879911*	I879921*	I879931*
I310g	I310g	I310g

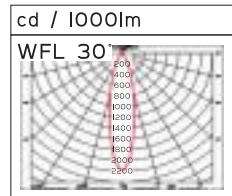

SP 19831120	FL 19831130	WFL 19831140
SP 19831170	FL 19831180	WFL 19831190

SP	19831120
FL	19831130
WFL	19831140



SP	19831170
FL	19831180
WFL	19831190



○	I9937105
○	I9937106
●	I9937109





Premium Horizon HF CDM-TD 70

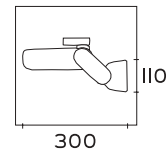
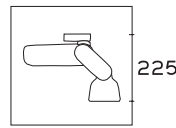
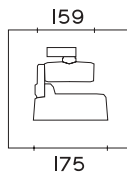

IP20
CL II
RX7s



CDM-TD

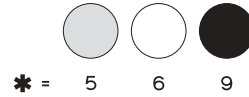

48 / pall

CDM-TD 70 HF
1871713*
1000g
cd / 1000lm



	I9937115
	I9937116
	I9937119



Premium Slim Par 20 HF CDM-R 35

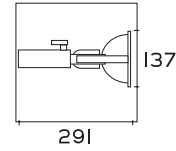
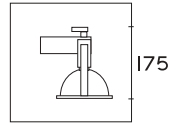
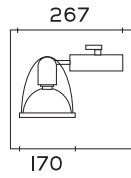

CDM-R
Par 20

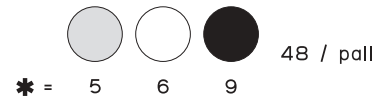

Par 20 35 HF	Par 20 35 HF
I870811*	I870812*
890g	890g
cd / 1000lm	cd / 1000lm



- I9937105
- I9937106
- I9937109





Premium Slim Par 30 HF CDM-R 35-70

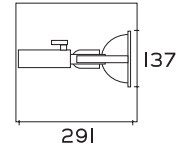
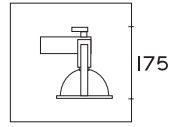
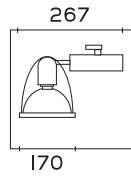

CDM-R
Par 30

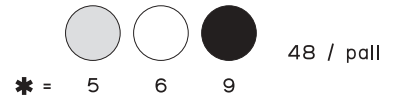

Par 30 35 HF	Par 30 35 HF
I870911*	I870912*
960g	960g
cd / 1000lm	cd / 1000lm

Par 30 70 HF	Par 30 70 HF
I870961*	I870962*
960g	960g
cd / 1000lm	cd / 1000lm



- I9937105
- I9937106
- I9937109





Premium Halogen HF Decostar IRC 35

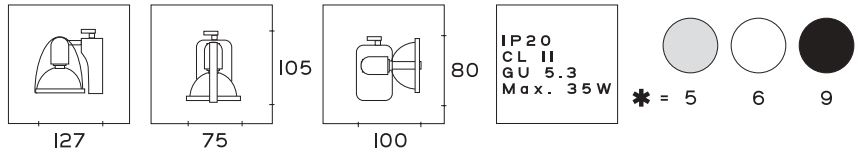

200 / pall



Decostar IRC

IRC 35 HF
1872311*
240g
cd / 1000lm
SP 10°
1000 2000 3000 4000 5000 6000 7000 8000 9000 10000 11000 12000 13000

IRC 35 HF
1872312*
240g
cd / 1000lm
FL 24°
2000 4000 6000 8000 10000 12000 14000 16000 18000 20000

IRC 35 HF
1872313*
240g
cd / 1000lm
WFL 38°
2000 4000 6000 8000 10000 12000 14000 16000 18000 20000



spot / flood



dynamic light



Mini-Master HF CDM-Tm 20

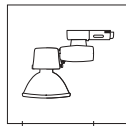

114

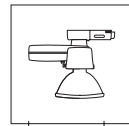

103

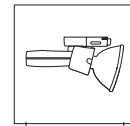

82



IP20
CL II
PGJ5



Mini-Master
CDM-Tm

163

* = 5 6 9

200 / pdII

CDM-Tm 20 HF
1291513*
223g
cd / 1000lm
SP 12°

CDM-Tm 20 HF
1291523*
223g
cd / 1000lm
FL 24°



- I9937145
- I9937146
- I9937149





Lival Mini-Master DL HF CDM-Tm 20

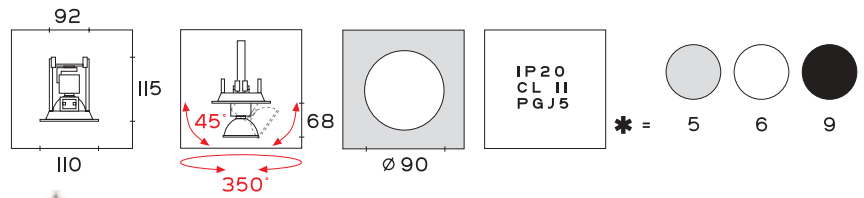

200 / pall

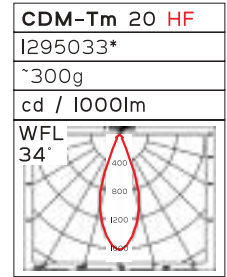
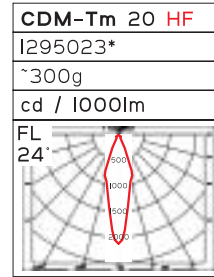
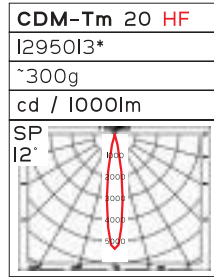

○ I9937145
○ I9937146
● I9937149



Shop-Master HF CDM-T 35-70 HF HCI-TC, CDM-TC 35

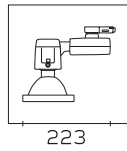

CDM-T

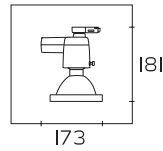

HCI-TC
CDM-TC

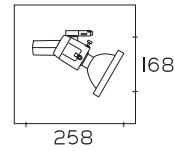

* = 5 6 9

IP 20
CL II
G12
G8.5

48 / pall

SPf 12'	FLf 24'	WFLf 44'
cd / 1000lm	cd / 1000lm	cd / 1000lm
CDM-T 35 HF	CDM-T 35 HF	CDM-T 35 HF
I281513*	I281523*	I281533*
670g	670g	670g
CDM-T 70 HF	CDM-T 70 HF	CDM-T 70 HF
I282513*	I282523*	I282533*
680g	680g	680g

SPf 12'	FLf 24'	WFLf 44'
cd / 1000lm	cd / 1000lm	cd / 1000lm
HCI-TC 35 HF	HCI-TC 35 HF	HCI-TC 35 HF
I283513*	I283523*	I283533*
660g	660g	660g





Shop-Master CDM-R111 HF CDM-R111 35-70

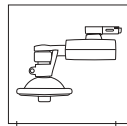

199

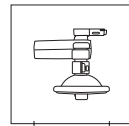

150

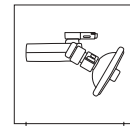

137

205

IP20
CL II
GX8.5



CDM-R111

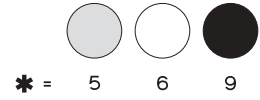

48 / pdII

* = 5 6 9

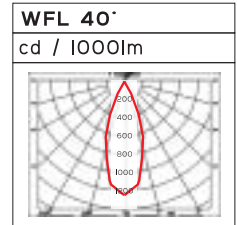
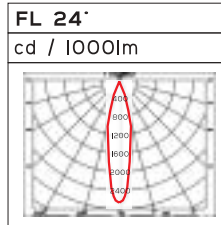
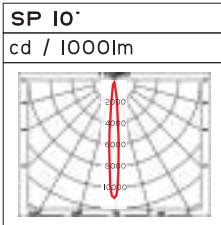

SP 10°	FL 24°	WFL 40°
CDM-R111 35 HF	CDM-R111 35 HF	CDM-R111 35 HF
I284513*	I284523*	I284533*
502g	502g	502g

SP 10°	FL 24°	WFL 40°
CDM-R111 70 HF	CDM-R111 70 HF	CDM-R111 70 HF
I285513*	I285523*	I285533*
504g	504g	504g





Titium

HF CDM-T, HCI-T, HQI-T 35-70
 HF HCI-TC, CDM-TC 35

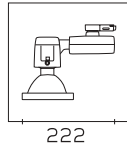

CDM-T

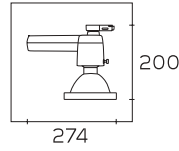

HCI-TC
CDM-TC

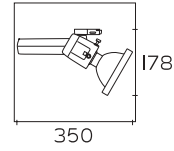

CDM-T

IP 20
CL II
G12
G8.5

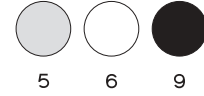

* = 5 6 9

48 / pall

SPf 12°	FLf 24°	WFLf 44°
cd / 1000lm	cd / 1000lm	cd / 1000lm
CDM-T 35 HF	CDM-T 35 HF	CDM-T 35 HF
I80151I*	I80152I*	I80153I*
840g	840g	840g
CDM-T 70 HF	CDM-T 70 HF	CDM-T 70 HF
I80251I*	I80252I*	I80253I*
850g	850g	850g

SPf 12°	FLf 24°	WFLf 44°
cd / 1000lm	cd / 1000lm	cd / 1000lm
HCI-TC 35 HF	HCI-TC 35 HF	HCI-TC 35 HF
I80451I*	I80452I*	I80453I*
820g	820g	820g





Cyli-con

HF / K CDM-T 35-70
 HF SDW-TG 50-100

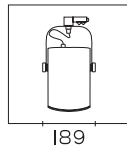

HF 302
 K 212

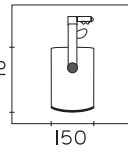

HF 410
 K 330

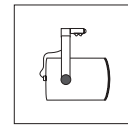

IP20
 CL I
 G12
 GX12

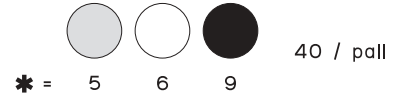

SPf 12'	FLf 24'	WFLf 44'
cd / 1000lm	cd / 1000lm	cd / 1000lm
CDM-T 35 HF	CDM-T 35 HF	CDM-T 35 HF
I675213*	I675223*	I675233*
2414g	2414g	2414g
CDM-T 70 HF	CDM-T 70 HF	CDM-T 70 HF
I676213*	I676223*	I676233*
2424g	2424g	2424g
CDM-T 35 K	CDM-T 35 K	CDM-T 35 K
I671213*	I671223*	I671233*
2835g	2835g	2835g
CDM-T 70 K	CDM-T 70 K	CDM-T 70 K
I672213*	I672223*	I672233*
3165g	3165g	3165g

SPf 12'	FLf 24'	WFLf 44'
cd / 1000lm	cd / 1000lm	cd / 1000lm
SDW-TG 50 HF	SDW-TG 50 HF	SDW-TG 50 HF
I678215*	I678225*	I678235*
2780g	2780g	2780g
SDW-TG 100 HF	SDW-TG 100 HF	SDW-TG 100 HF
I679215*	I679225*	I679235*
2784g	2784g	2784g





Hawk HF / K CDM-T 70-150 / HF SDW-TG 50-100

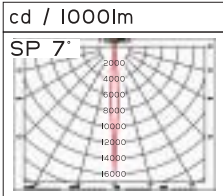
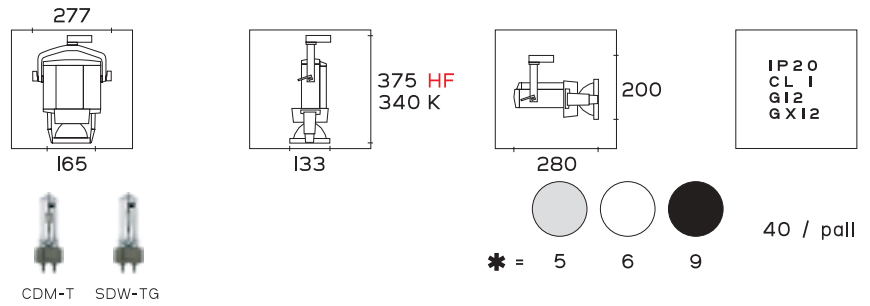

SP 7°	
CDM-T 70 HF	CDM-T 70 K
I943213*	I941213*
1880g	2970g

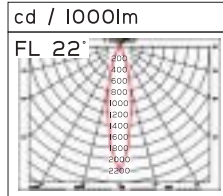

FL 22°	
CDM-T 70 HF	CDM-T 70 K
I943223*	I941223*
1880g	2970g

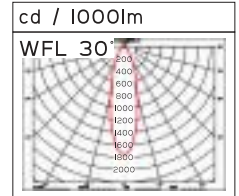

WFL 30°	
CDM-T 70 HF	CDM-T 70 K
I943233*	I941233*
1880g	2970g

SP 7°	FL 22°	WFL 30°
CDM-T 150 K	CDM-T 150 K	CDM-T 150 K
I942213*	I942223*	I942233*
3780g	3780g	3780g

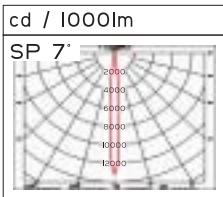

SP 7°	FL 22°	WFL 30°
SDW-TG 50 HF	SDW-TG 50 HF	SDW-TG 50 HF
I948213*	I948223*	I948233*
2300g	2300g	2300g

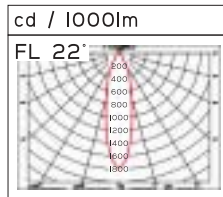

SP 7°	FL 22°	WFL 30°
SDW-TG 100 HF	SDW-TG 100 HF	SDW-TG 100 HF
I949213*	I949223*	I949233*
2300g	2300g	2300g

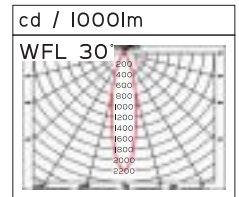

SP	I9831120	
FL	I9831130	
WFL	I9831140	

SP	I9831170	
FL	I9831180	
WFL	I9831190	



the light you feel



Exus K Dulux F 36

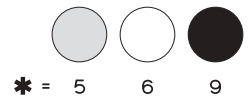
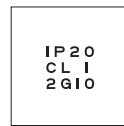
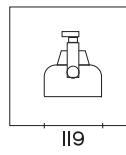
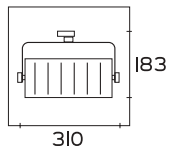

80 / pall



Dulux F

Dulux F 36 K
I732013*
1840g
cd / 1000lm



<input type="radio"/> I9961616
<input checked="" type="radio"/> I9961619





Hexus B

Hexus B / Hexus

HF PL-H 60-85-120
HF Dulux T/E 2x42

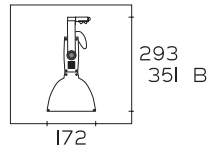

PL-H



Dulux T/E IN

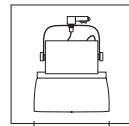

60/85W
120W
2x42W

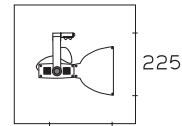

* = 5 6 9

IP20
CL I
2GB
GX24q-4

32 / pall

HEXUS			
PL-H 60/830 HF	PL-H 85/830 HF	PL-H 120/830 HF	T/E 2x42/830 HF
I584113*	I584123*	I584133*	I584323*
2247g	2281g	2495g	2638g
cd / 1000lm	cd / 1000lm	cd / 1000lm	cd / 1000lm

HEXUS B			
PL-H 60/830 HF	PL-H 85/830 HF	PL-H 120/830 HF	T/E 2x42/830 HF
I581113*	I581123*	I581133*	I581323*
2361g	2395g	2609g	2752g
cd / 1000lm	cd / 1000lm	cd / 1000lm	cd / 1000lm



Hexus







Function DL E HF

HF CDM-T 35-70
HF SDW-TG 50-100

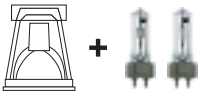
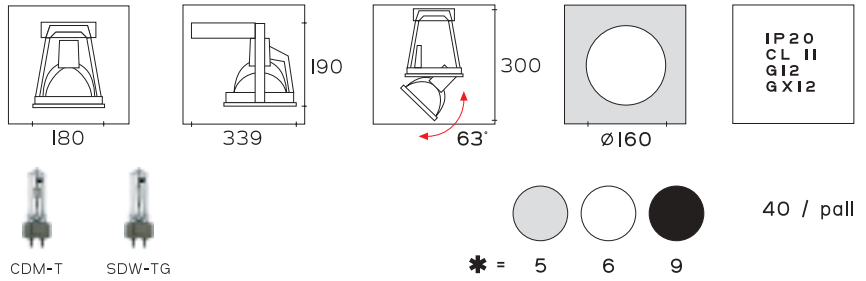

SPf 12°	FLf 24°	WFLf 44°
cd / 1000lm	cd / 1000lm	cd / 1000lm
CDM-T 35 HF	CDM-T 35 HF	CDM-T 35 HF
I86536I*	I86537I*	I86538I*
I063g	I063g	I063g
CDM-T 70 HF	CDM-T 70 HF	CDM-T 70 HF
I86576I*	I86577I*	I86578I*
I095g	I095g	I095g

SPf 12°	FLf 24°	WFLf 44°
cd / 1000lm	cd / 1000lm	cd / 1000lm
SDW-TG 50 HF	SDW-TG 50 HF	SDW-TG 50 HF
I86986I*	I86987I*	I86988I*
I424g	I424g	I424g
SDW-TG 100 HF	SDW-TG 100 HF	SDW-TG 100 HF
I86996I*	I86997I*	I86998I*
I424g	I424g	I424g





Function DL E HF

HF CDM-T 35-70
HF SDW-TG 50-100

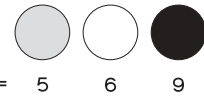
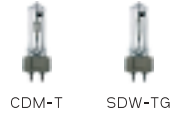
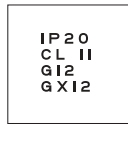
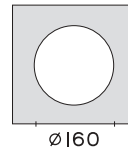
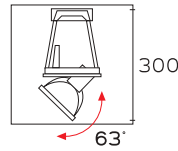
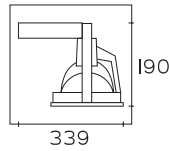
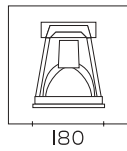

40 / pall

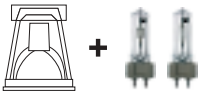

SPf 12°	FLf 24°	WFLf 44°
cd / 1000lm	cd / 1000lm	cd / 1000lm
CDM-T 35 HF	CDM-T 35 HF	CDM-T 35 HF
I86536I*	I86537I*	I86538I*
I063g	I063g	I063g
CDM-T 70 HF	CDM-T 70 HF	CDM-T 70 HF
I86576I*	I86577I*	I86578I*
I095g	I095g	I095g

SPf 12°	FLf 24°	WFLf 44°
cd / 1000lm	cd / 1000lm	cd / 1000lm
SDW-TG 50 HF	SDW-TG 50 HF	SDW-TG 50 HF
I86986I*	I86987I*	I86988I*
I424g	I424g	I424g
SDW-TG 100 HF	SDW-TG 100 HF	SDW-TG 100 HF
I86996I*	I86997I*	I86998I*
I424g	I424g	I424g





Function DL HF / K CDM-T 35-70 / SDW-TG 50-100

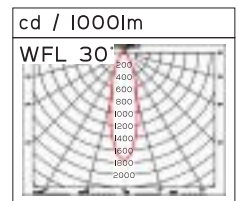
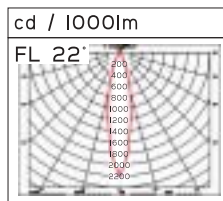
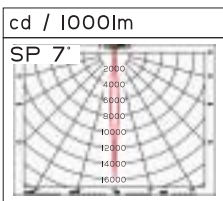
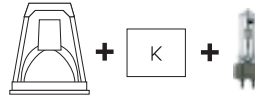
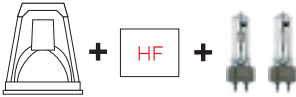
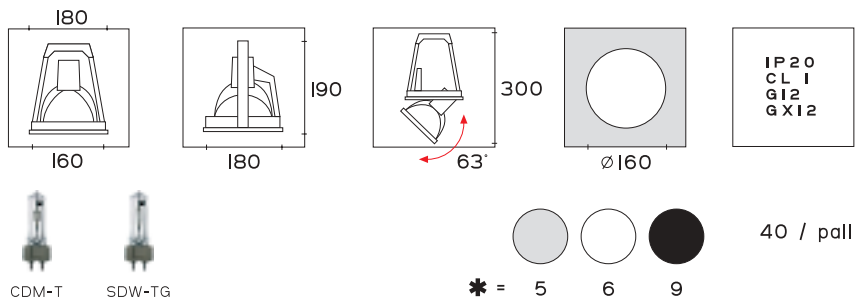

SP 7°	FL 22°	WFL 30°
CDM-T 35 HF	CDM-T 35 HF	CDM-T 35 HF
186831I*	186832I*	186833I*
950g	950g	950g
CDM-T 70 HF	CDM-T 70 HF	CDM-T 70 HF
186871I*	186872I*	186873I*
950g	950g	950g

SP 7°	FL 22°	WFL 30°
CDM-T 35 K	CDM-T 35 K	CDM-T 35 K
186331I*	186332I*	186333I*
2240g	2240g	2240g
CDM-T 70 K	CDM-T 70 K	CDM-T 70 K
186371I*	186372I*	186373I*
2570g	2570g	2570g



ca / 1000lm	ca / 1000lm	ca / 1000lm
SP 7°	FL 22°	WFL 30°
SDW-TG 50 HF	SDW-TG 50 HF	SDW-TG 50 HF
186951I*	186952I*	186953I*
1310g	1310g	1310g
SDW-TG 100 HF	SDW-TG 100 HF	SDW-TG 100 HF
186971I*	186972I*	186973I*
1310g	1310g	1310g





Function DL HF / K CDM-R Par 20 35

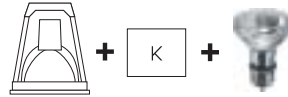
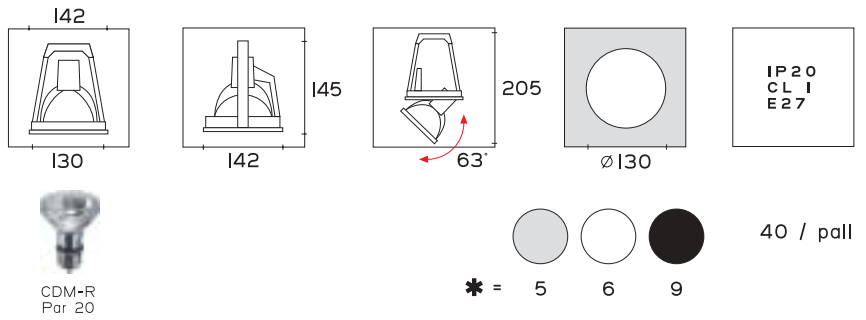

Par 20 35 HF	Par 20 35 HF
I866301*	I866302*
610g	610g
cd / 1000lm	cd / 1000lm
SP 10°	FL 40°

Par 20 35 K	Par 20 35 K
I861301*	I861302*
1970g	1970g
cd / 1000lm	cd / 1000lm
SP 10°	FL 40°





Function DL HF / K CDM-R Par 30 35-70

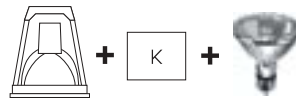
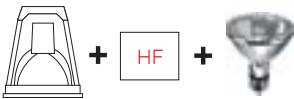
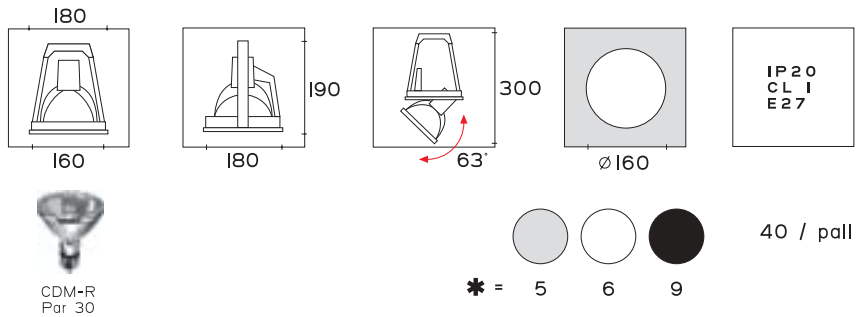

Par 30 35 HF	Par 30 35 HF
I867301*	I867302*
680g	680g
cd / 1000lm	cd / 1000lm
SP 10°	FL 40°

Par 30 35 K	Par 30 35 K
I862301*	I862302*
2040g	2040g
cd / 1000lm	cd / 1000lm
SP 10°	FL 40°

Par 30 70 HF	Par 30 70 HF
I867701*	I867702*
750g	750g
cd / 1000lm	cd / 1000lm
SP 10°	FL 40°

Par 30 70 K	Par 30 70 K
I862701*	I862702*
2370g	2370g
cd / 1000lm	cd / 1000lm
SP 10°	FL 40°





Mond E HF HF CDM-T 35-70 HF SDW-TG 50-100

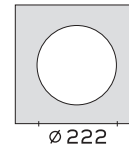
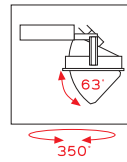
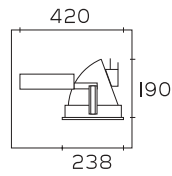

IP 20
CL II
G12
GX12

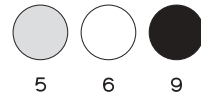

36 / pall

* = 5 6 9

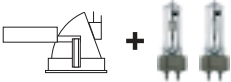

SP 13°	FL 23°	WFL 46°
cd / 1000lm	cd / 1000lm	cd / 1000lm
CDM-T 35 HF	CDM-T 35 HF	CDM-T 35 HF
1831913*	1831943*	1831973*
1587g	1587g	1587g
CDM-T 70 HF	CDM-T 70 HF	CDM-T 70 HF
1832913*	1832943*	1832973*
1619g	1619g	1619g

SP 13°	FL 23°	WFL 46°
cd / 1000lm	cd / 1000lm	cd / 1000lm
SDW-TG 50 HF	SDW-TG 50 HF	SDW-TG 50 HF
1838011X*	1838041*	1838071*
1943g	1943g	1943g
SDW-TG 100 HF	SDW-TG 100 HF	SDW-TG 100 HF
1837911*	1837941*	1837971*
1948g	1948g	1948g



SP = R-1	
FL = R-4	
WFL = R-10	

SP = R-2	
FL = R-5	
WFL = R-11	

SP = R-3	
FL = R-6	
WFL = R-12	



Mond **HF** / K CDM-T 35-70

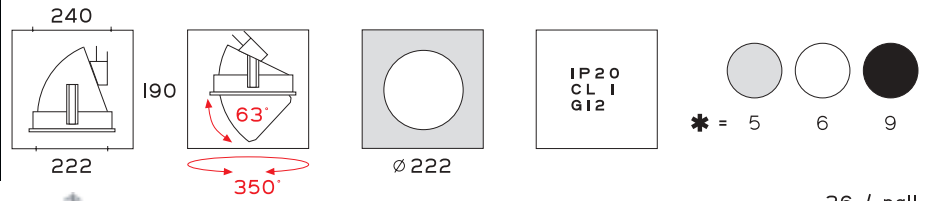

36 / pall

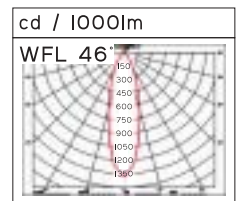
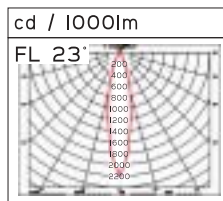
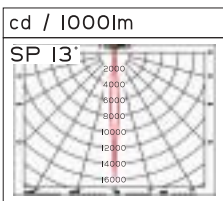

SP 13°	
CDM-T 35 HF	CDM-T 35 K
1831913*	1831113*
1550g	2710g
CDM-T 70 HF	CDM-T 70 K
1832913*	1832113*
1620g	3040g

FL 23°	
CDM-T 35 HF	CDM-T 35 K
1831943*	1831143*
1550g	2710g
CDM-T 70 HF	CDM-T 70 K
1832943*	1832143*
1620g	3040g

WFL 46°	
CDM-T 35 HF	CDM-T 35 K
1831973*	1831173*
1550g	2710g
CDM-T 70 HF	CDM-T 70 K
1832973*	1832173*
1620g	3040g

SP = R-1	
FL = R-4	
WFL = R-10	

SP = R-2	
FL = R-5	
WFL = R-11	

SP = R-3	
FL = R-6	
WFL = R-12	

HF

K



Mond HF SDW-TG 50-100 / K SDW-T 50-100

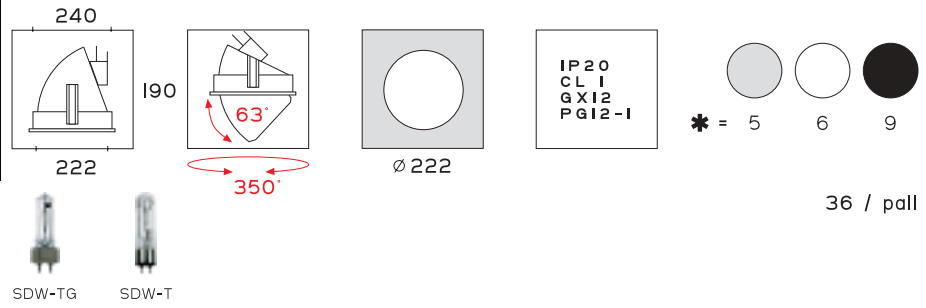

36 / pall

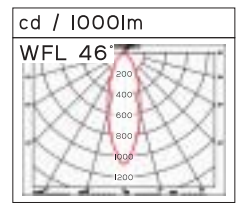
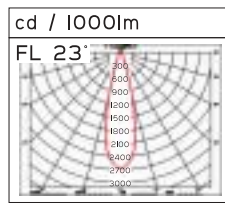
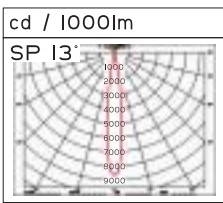

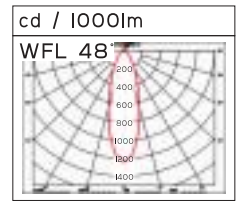
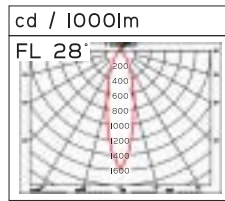
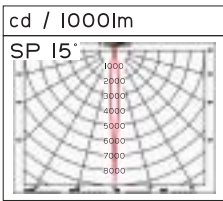

SP 13°	FL 23°	WFL 46°	SP 13°	FL 23°	WFL 46°
SDW-TG 50 HF	SDW-TG 50 HF	SDW-TG 50 HF	SDW-TG 100 HF	SDW-TG 100 HF	SDW-TG 100 HF
I8378II*	I83784I*	I83787I*	I8379II*	I83794I*	I83797I*
I900g	I900g	I900g	I900g	I900g	I900g



SP 15°	FL 28°	WFL 48°	SP 15°	FL 28°	WFL 48°
SDW-T 50 K	SDW-T 50 K	SDW-T 50 K	SDW-T 100 K	SDW-T 100 K	SDW-T 100 K
I836III*	I836I4I*	I836I7I*	I837III*	I837I4I*	I837I7I*
2700g	2700g	2700g	3I30g	3I30g	3I30g



SP = R-1	
FL = R-4	
WFL = R-10	

SP = R-2	
FL = R-5	
WFL = R-11	

SP = R-3	
FL = R-6	
WFL = R-12	

HF



K





Super DL E HF

HF CDM-T 35-70
HF SDW-TG 50-100

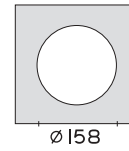
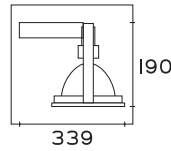
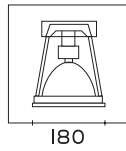

IP 20
CL II
G12
GX12

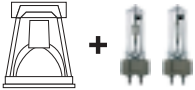
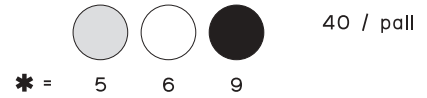

SP 13°	FL 23°	WFL 46°
cd / 1000lm	cd / 1000lm	cd / 1000lm
CDM-T 35 HF	CDM-T 35 HF	CDM-T 35 HF
I8509II*	I85094I*	I85097I*
I019g	I019g	I019g
CDM-T 70 HF	CDM-T 70 HF	CDM-T 70 HF
I850III*	I850I4I*	I850I7I*
I05Ilg	I05Ilg	I05Ilg

SP 13°	FL 23°	WFL 46°
cd / 1000lm	cd / 1000lm	cd / 1000lm
SDW-TG 50 HF	SDW-TG 50 HF	SDW-TG 50 HF
I8580II*	I85804I*	I85807I*
I375g	I375g	I375g
SDW-TG 100 HF	SDW-TG 100 HF	SDW-TG 100 HF
I8590II*	I85904I*	I85907I*
I380g	I380g	I380g



SP = R-1
FL = R-4
WFL = R-10



SP = R-2
FL = R-5
WFL = R-11

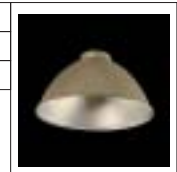

SP = R-3
FL = R-6
WFL = R-12

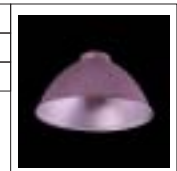



Super DL HF / K CDM-T 35-70 / SDW-T/TG 50-100

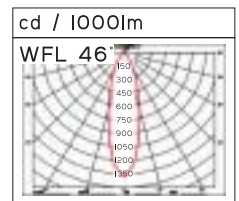
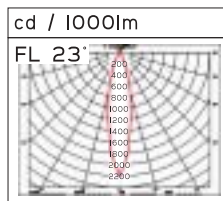
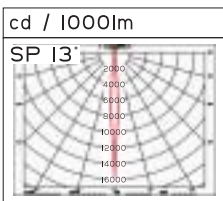
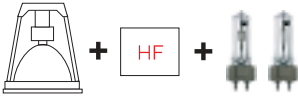
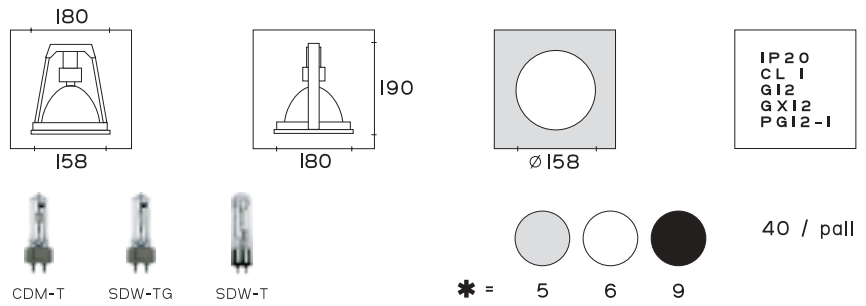

SP 13°	FL 23°	WFL 46°
CDM-T 35 HF	CDM-T 35 HF	CDM-T 35 HF
I8519I3*	I851943*	I851973*
830g	830g	830g
CDM-T 70 HF	CDM-T 70 HF	CDM-T 70 HF
I854II3*	I854I43*	I854I73*
900g	900g	900g

SP 13°	FL 23°	WFL 46°
CDM-T 35 K	CDM-T 35 K	CDM-T 35 K
I851I3*	I851I43*	I851I73*
2190g	2190g	2190g
CDM-T 70 K	CDM-T 70 K	CDM-T 70 K
I852II3*	I852I43*	I852I73*
2520g	2520g	2520g

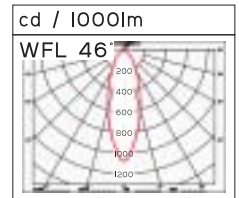
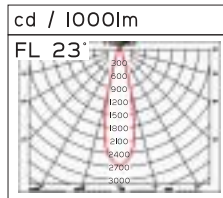
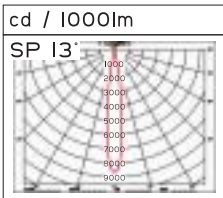

SP 13°	FL 23°	WFL 46°
SDW-TG 50 HF	SDW-TG 50 HF	SDW-TG 50 HF
I8566II*	I85664I*	I85667I*
II60g	II60g	II60g

SP 13°	FL 23°	WFL 46°
SDW-TG 100 HF	SDW-TG 100 HF	SDW-TG 100 HF
I8576II*	I85764I*	I85767I*
II60g	II60g	II60g

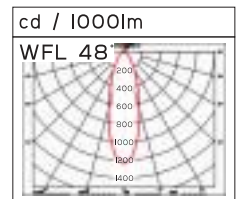
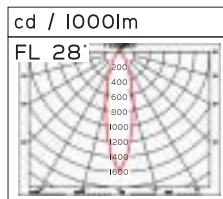
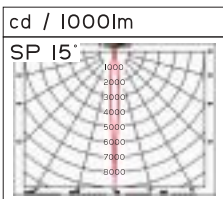

SP 15°	FL 28°	WFL 48°
SDW-T 50 K	SDW-T 50 K	SDW-T 50 K
I856III*	I856I4I*	I856I7I*
2200g	2200g	2200g

SP 15°	FL 28°	WFL 48°
SDW-T 100 K	SDW-T 100 K	SDW-T 100 K
I857III*	I857I4I*	I857I7I*
2630g	2630g	2630g





Form HF / K CDM-T 35-70 / SDW-TG 50-100 / Par 30 35-70

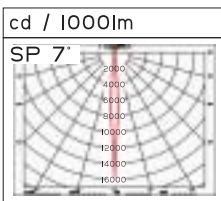
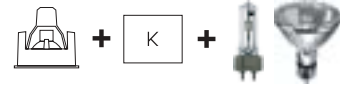
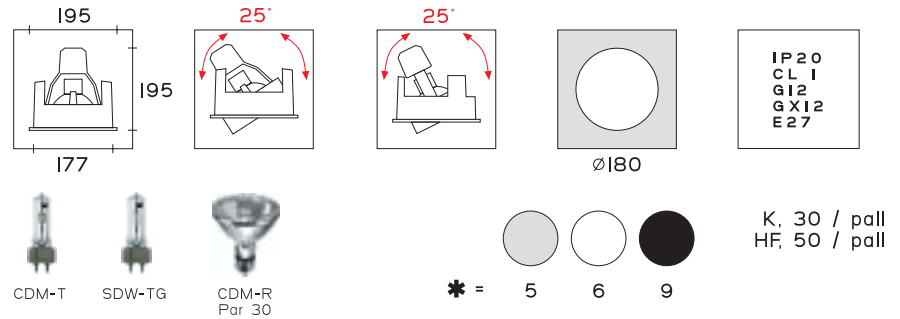

SP 7°	
CDM-T 35 HF	CDM-T 35 K
I093613*	I093113*
I070g	2430g
CDM-T 70 HF	CDM-T 70 K
I094613*	I094113*
1140g	2760g

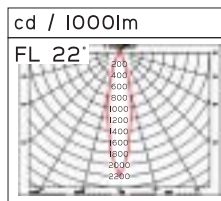

FL 22°	
CDM-T 35 HF	CDM-T 35 K
I093643*	I093143*
I070g	2430g
CDM-T 70 HF	CDM-T 70 K
I094643*	I094143*
1140g	2760g

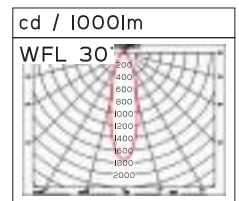

WFL 30°	
CDM-T 35 HF	CDM-T 35 K
I093673*	I093173*
I070g	2430g
CDM-T 70 HF	CDM-T 70 K
I094673*	I094173*
1140g	2760g

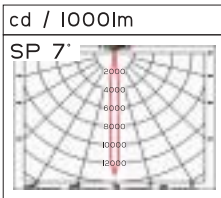

SP 7°	FL 22°	WFL 30°
SDW-TG 50 HF	SDW-TG 50 HF	SDW-TG 50 HF
I099111*	I099141*	I099171*
I500g	I500g	I500g

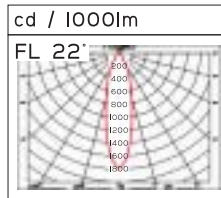

SP 7°	FL 22°	WFL 30°
SDW-TG 100 HF	SDW-TG 100 HF	SDW-TG 100 HF
I099611*	I099641*	I099671*
I500g	I500g	I500g

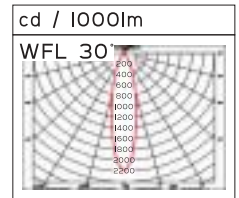

Par 30 35 HF		Par 30 35 K	
I098601*		I098501*	
1170g		2530g	
SP		FL	

Par 30 35 HF		Par 30 35 K	
I098602*		I098502*	
1170g		2530g	
SP		FL	



Par 30 70 HF		Par 30 70 K	
I098901*		I098801*	
1240g		2860g	
SP		FL	

Par 30 70 HF		Par 30 70 K	
I098902*		I098802*	
1240g		2860g	
SP		FL	





Form KVADRAT HF / K CDM-T 35-70 / CDM-R111 35-70

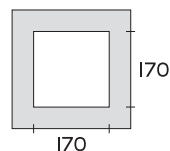
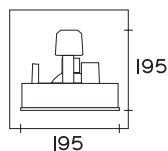
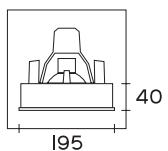

IP20
CL I
G12
G53



CDM-T

CDM-R111

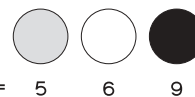

* = 5 6 9

K, 30 / pall
HF, 50 / pall

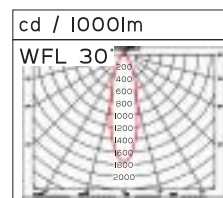
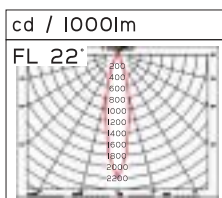
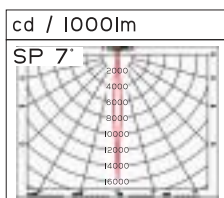

SP 7°	
CDM-T 35 HF	CDM-T 35 K
1095713*	1095613*
1210g	2570g
CDM-T 70 HF	CDM-T 70 K
1095213*	1095113*
1280g	2900g

FL 22°	
CDM-T 35 HF	CDM-T 35 K
1095743*	1095643*
1210g	2570g
CDM-T 70 HF	CDM-T 70 K
1095243*	1095143*
1280g	2900g

WFL 30°	
CDM-T 35 HF	CDM-T 35 K
1095773*	1095673*
1210g	2570g
CDM-T 70 HF	CDM-T 70 K
1095273*	1095173*
1280g	2900g

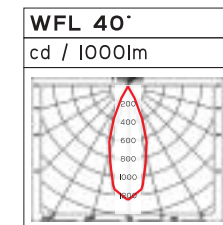
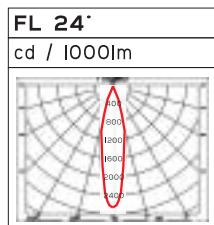
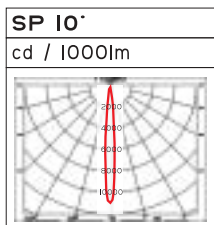

SP 10°	
CDM-R111 35 HF	CDM-R111 70 HF
1095913*	1095413*
1099g	1169g
CDM-R111 35 K	CDM-R111 70 K
1095813*	1095313*
2459g	2789g

FL 24°	
CDM-R111 35 HF	CDM-R111 70 HF
1095923*	1095423*
1099g	1169g
CDM-R111 35 K	CDM-R111 70 K
1095823*	1095323*
2459g	2789g

WFL 40°	
CDM-R111 35 HF	CDM-R111 70 HF
1095933*	1095433*
1099g	1169g
CDM-R111 35 K	CDM-R111 70 K
1095833*	1095333*
2459g	2789g





Form Duo **HF** / K CDM-T 35-70 / CDM-RIII 35-70

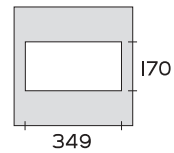
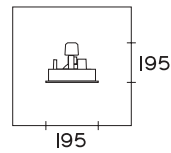
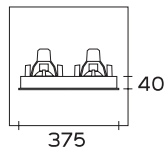

IP 20
CL I
G12
G53

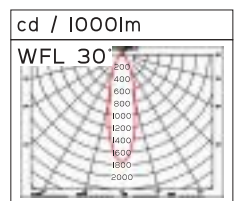
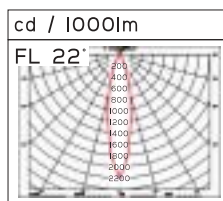
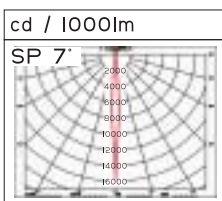
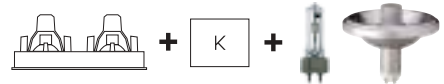
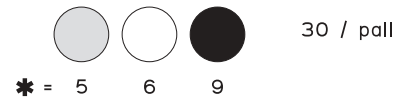
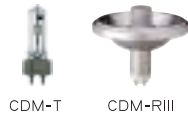

SP 7°	
CDM-T 35 HF	CDM-T 35 K
1096713*	1096613*
2290g	5010g

FL 22°	
CDM-T 35 HF	CDM-T 35 K
1096743*	1096643*
2290g	5010g

WFL 30°	
CDM-T 35 HF	CDM-T 35 K
1096773*	1096673*
2290g	5010g

CDM-T 70 HF	CDM-T 70 K
1096213*	1096113*
2430g	5670g

CDM-T 70 HF	CDM-T 70 K
1096243*	1096143*
2430g	5670g

CDM-T 70 HF	CDM-T 70 K
1096273*	1096173*
2430g	5670g

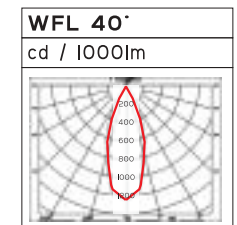
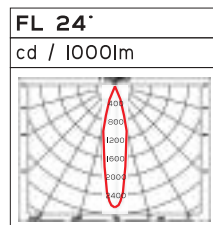
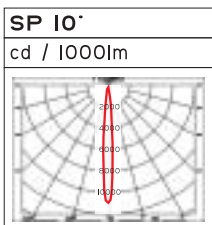

SP 10°	
CDM-RIII 35 HF	CDM-RIII 70 HF
1096813*	1096413*
2067g	2207g

FL 24°	
CDM-RIII 35 HF	CDM-RIII 70 HF
1096823*	1096423*
2067g	2207g

WFL 40°	
CDM-RIII 35 HF	CDM-RIII 70 HF
1096833*	1096433*
2067g	2207g

CDM-RIII 35 K	CDM-RIII 70 K
1096713*	1096313*
4787g	5447g

CDM-RIII 35 K	CDM-RIII 70 K
1096723*	1096323*
4787g	5447g

CDM-RIII 35 K	CDM-RIII 70 K
1096733*	1096333*
4787g	5447g





Form Trio HF / K CDM-T 35-70 / CDM-R111 35-70

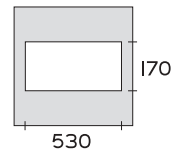
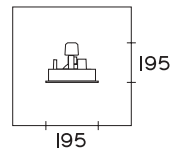
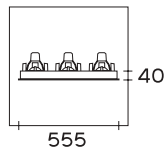

IP 20
CL I
G12
G53

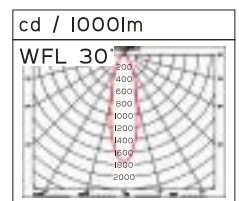
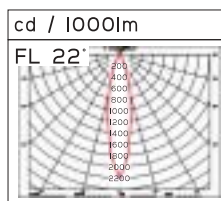
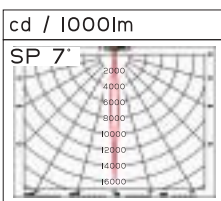
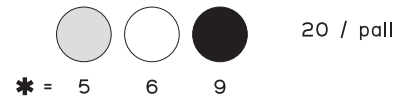

SP 7°	
CDM-T 35 HF	CDM-T 35 K
1097713*	1097613*
3370g	7450g
CDM-T 70 HF	CDM-T 70 K
1097213*	1097113*
3580g	8440g

FL 22°	
CDM-T 35 HF	CDM-T 35 K
1097743*	1097643*
3370g	7450g
CDM-T 70 HF	CDM-T 70 K
1097243*	1097143*
3580g	8440g

WFL 30°	
CDM-T 35 HF	CDM-T 35 K
1097773*	1097673*
3370g	7450g
CDM-T 70 HF	CDM-T 70 K
1097273*	1097173*
3580g	8440g

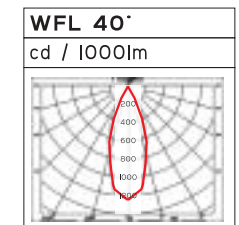
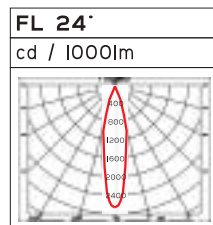
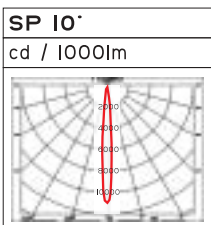

SP 10°	
CDM-R111 35 HF	CDM-R111 70 HF
1097813*	1097413*
3036g	3246g
CDM-R111 35 K	CDM-R111 70 K
1097713*	1097313*
7116g	8106g

FL 24°	
CDM-R111 35 HF	CDM-R111 70 HF
1097823*	1097423*
3036g	3246g
CDM-R111 35 K	CDM-R111 70 K
1097723*	1097323*
7116g	8106g

WFL 40°	
CDM-R111 35 HF	CDM-R111 70 HF
1097833*	1097433*
3036g	3246g
CDM-R111 35 K	CDM-R111 70 K
1097733*	1097333*
7116g	8106g



Form Quattro HF / K CDM-T 35-70 / CDM-RIII 35-70

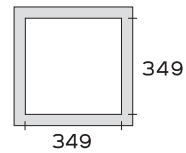
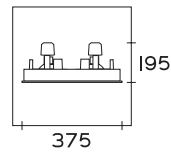
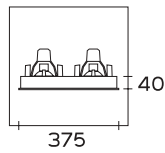

IP20
CL I
G12
GX8.5

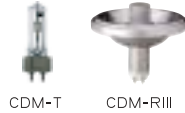

18 / pall
* = 5 6 9

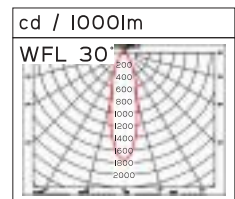
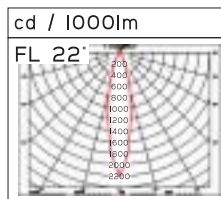
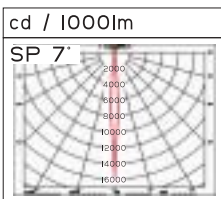
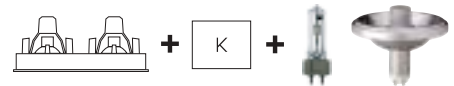

SP 7°	
CDM-T 35 HF	CDM-T 35 K
I09A713*	I09A613*
4623g	I0063g

FL 22°	
CDM-T 35 HF	CDM-T 35 K
I09A743*	I09A643*
4623g	I0063g

WFL 30°	
CDM-T 35 HF	CDM-T 35 K
I09A773*	I09A673*
4623g	I0063g

CDM-T 70 HF		CDM-T 70 K	
I09A213*	I09A113*		
4903g	I1383g		

CDM-T 70 HF		CDM-T 70 K	
I09A243*	I09A143*		
4903g	I1383g		

CDM-T 70 HF		CDM-T 70 K	
I09A273*	I09A173*		
4903g	I1383g		

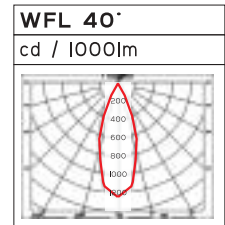
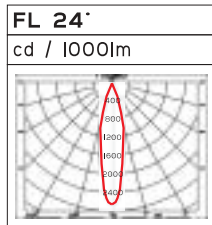
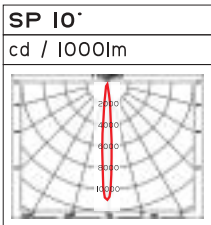

SP 10°	
CDM-RIII 35 HF	CDM-RIII 70 HF
I09A813*	I09A413*
4029g	4309g

FL 24°	
CDM-RIII 35 HF	CDM-RIII 70 HF
I09A823*	I09A423*
4029g	4309g

WFL 40°	
CDM-RIII 35 HF	CDM-RIII 70 HF
I09A833*	I09A433*
4029g	4309g

CDM-RIII 35 K		CDM-RIII 70 K	
I09A713*	I09A313*		
9469g	I0789g		

CDM-RIII 35 K		CDM-RIII 70 K	
I09A723*	I09A323*		
9469g	I0789g		

CDM-RIII 35 K		CDM-RIII 70 K	
I09A733*	I09A333*		
9469g	I0789g		





Pistol DL HF -TC 20-35

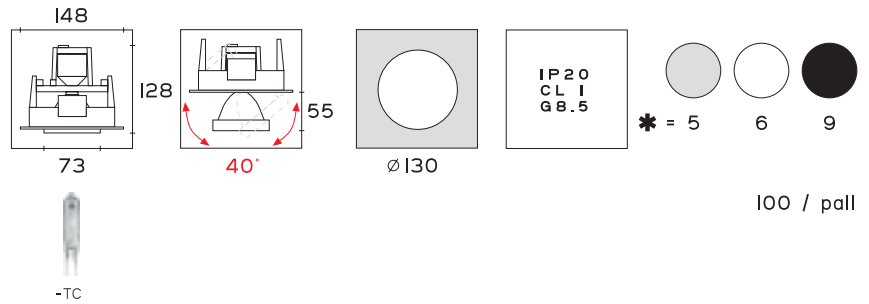

-TC 20 HF	-TC 20 HF	-TC 20 HF
I300111*	I300121*	I300131*
426g	426g	426g
cd / 1000lm	cd / 1000lm	cd / 1000lm
SP 9°	FL 25°	WFL 35° OPTIONAL

-TC 35 HF	-TC 35 HF	-TC 35 HF
I300611*	I300621*	I300631*
460g	460g	460g
cd / 1000lm	cd / 1000lm	cd / 1000lm
SP 9°	FL 25°	WFL 35° OPTIONAL

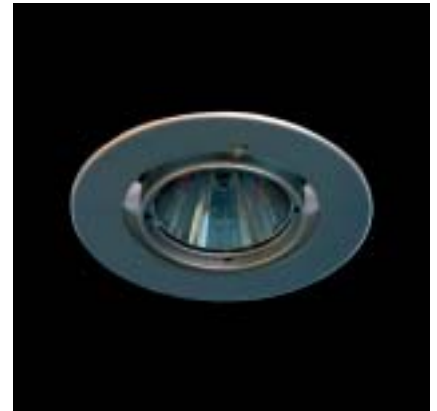



Pistol HF -TC 20-35

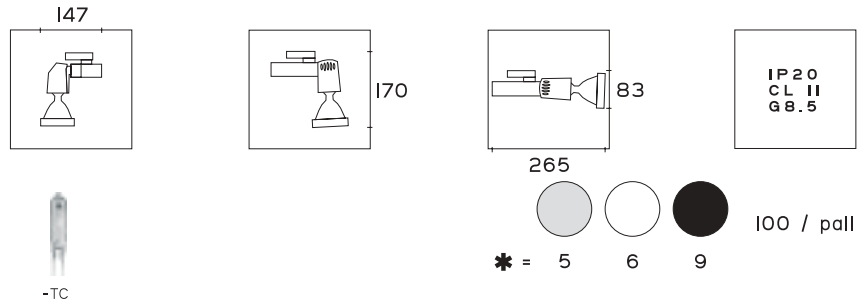

-TC 20 HF	-TC 20 HF	-TC 20 HF	-TC 35 HF	-TC 35 HF	-TC 35 HF
I30151I*	I30152I*	I30153I*	I30251I*	I30252I*	I30253I*
480g	480g	480g	480g	480g	480g
cd / 1000lm	cd / 1000lm	cd / 1000lm	cd / 1000lm	cd / 1000lm	cd / 1000lm
<p>SP 9°</p>	<p>FL 25°</p>	<p>WFL 35°</p> <p>OPTIONAL</p>	<p>SP 9°</p>	<p>FL 25°</p>	<p>WFL 35°</p> <p>OPTIONAL</p>





Pistol Halogen HF Decostar Titan 35-50

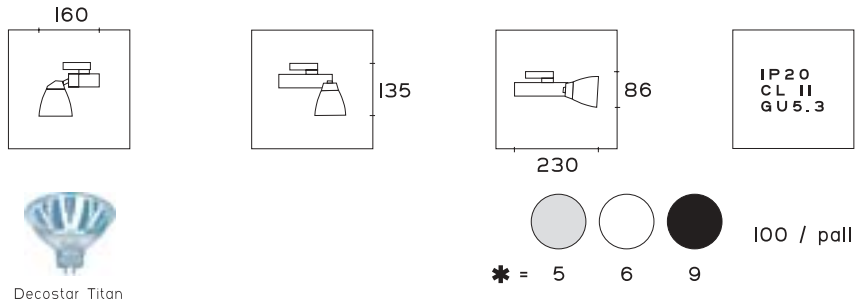

Titan 35 HF	Titan 35 HF	Titan 35 HF
I303511*	I303512*	I303513*
350g	350g	350g
cd / 1000lm	cd / 1000lm	cd / 1000lm

Titan 50 HF	Titan 50 HF	Titan 50 HF
I304511*	I304512*	I304513*
350g	350g	350g
cd / 1000lm	cd / 1000lm	cd / 1000lm



SP 10°	FL 24°	WFL 38°
Plus, Titan 35 HF	Plus, Titan 35 HF	Plus, Titan 35 HF
I305521*	I305522*	I305523*
406g	406g	406g
Plus, Titan 50 HF	Plus, Titan 50 HF	Plus, Titan 50 HF
I306521*	I306522*	I306523*
406g	406g	406g





Pistol CDM-RIII HF CDM-RIII 35

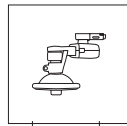

159

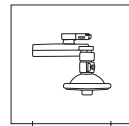

146

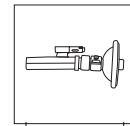

240

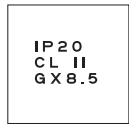

IP20
CL II
GX8.5



CDM-RIII

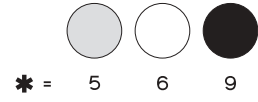

100 / pdII

CDM-RIII 35 HF	CDM-RIII 35 HF	CDM-RIII 35 HF
SP 10°	FL 24°	WFL 40°
I307345*	I307355*	I307365*
456g	456g	456g
cd / 1000lm	cd / 1000lm	cd / 1000lm





Power DL HF / K CDM-TD 70 / K SDW-T 100

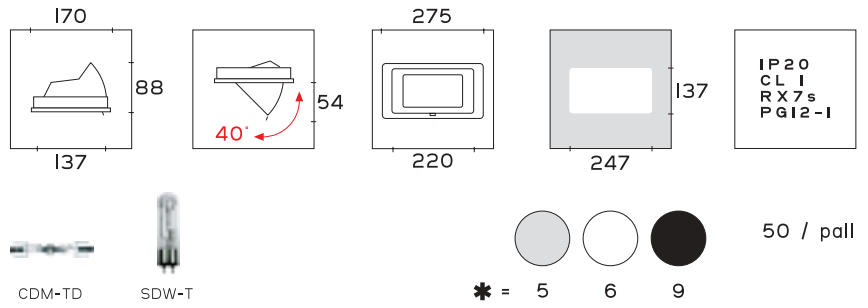

CDM-TD 70 HF
1849103*
1080g
cd / 1000lm

CDM-TD 70 K
1842103*
2700g
cd / 1000lm

SDW-T 100 K
1847101*
2810g
cd / 1000lm



Powergears

HF

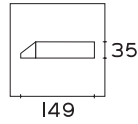

CDM-T 35 HF	CDM-T 70 HF
I9844424	I9844524
240g	240g

CDM-T

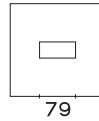

CDM-T 35 HF	CDM-T 70 HF
I9904426	I9904458
472g	472g

HF

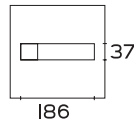

CDM-T 35 HF	CDM-T 70 HF
I9844423	I9844523
290g	360g

CDM-T I50 HF
I9844573
500g

CDM-T

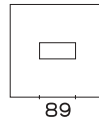

CDM-T 35 HF	CDM-T 70 HF
I9904425	I9904525
520g	590g

CDM-T I50 HF
I9904575
730g

HF

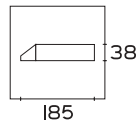

SDW-TG 50 HF	SDW-TG 100 HF
I9844450	I9844540
720g	720g

SDW-TG

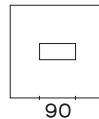

SDW-TG 50 HF	SDW-TG 100 HF
I9904455	I9904545
950g	950g

K

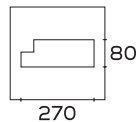

CDM-T 35 K	CDM-T 70 K
I8930009	I8931009
I650g	I980g

SDW-T 50 K	SDW-T 100 K
I8941009	I8942009
I760g	I2190g

CDM-T
SDW-T

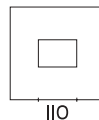









CDM-T 35 K	CDM-T 70 K
I8930329	I8931329
I880g	I2210g

SDW-T 50 K	SDW-T 100 K
I8941329	I8942329
I990g	I2420g



dynamic light

Classics

Forte CDM-T		35 / pall	CDM-T 70 K ○ I692I135 2980g SP 7'	CDM-T 70 K ○ I692I235 2980g FL 22'	CDM-T 70 K ○ I692I335 2980g WFL 30'
Forte SDW-T		35 / pall	SDW-T 100 K ○ I695I115 3260g SP 8'	SDW-T 100 K ○ I695I215 3260g FL 23'	SDW-T 100 K ○ I695I315 3260g WFL 32'
Power CDM-T		50 / pall	CDM-T 70 K ○ I572I135 2960g SP 7'	CDM-T 70 K ○ I572I235 2960g FL 22'	CDM-T 70 K ○ I572I335 2960g WFL 30'
Power CDM-TD		50 / pall	CDM-TD 70 K ○ I652I035 3180g WFL	CDM-TD 150 K ○ I657I035 4060g WFL	○ I996I215 ○ I996I216 ● I996I219 
CB-500		200 / pall	IRC 50 HF ○ I5940I15 550g SP 10'	IRC 50 HF ○ I5940I25 550g FL 24'	IRC 50 HF ○ I5940I35 550g WFL 38'
CB-50I		200 / pall	IRC 50 HF ○ I6440I15 500g SP 10'	IRC 50 HF ○ I6440I25 500g FL 24'	IRC 50 HF ○ I6440I35 500g WFL 38'
Balance		200 / pall	IRC 50 HF ○ I7440I15 320g SP 10'	IRC 50 HF (FL) ○ I7440I25 320g FL 24'	IRC 50 HF ○ I7440I35 320g WFL 38'

Light sources

CDM-T

CDM-T 35	3300lm
CDM-T 70	6600lm
CDM-T 150	14000lm
 GI2	



SDW-T White SON

SDW-T 35	1300lm
SDW-T 50	2300lm
SDW-T 100	5000lm
 PGI2-I	



HCI-T Powerball

HCI-T Pb/WDL 35	3300lm
HCI-T Pb/WDL 70	6700lm
HCI-T Pb/WDL 150	14500lm
 GI2	



SDW-TG Mini White SON

SDW-TG 50	2300lm
SDW-TG 100	4800lm
 GXI2-I	



CDM-Tm Mini-Master

CDM-Tm 20	1500lm
 PGJ5	



HCI-TC Powerball / CDM-TC

HCI-TC Pb/WDL 35	3300lm
CDM-TC 35	3300lm
 G8.5	



CDM-TD

CDM-TD 70	6500lm
CDM-TD 150	13250lm
 70: RX7s 150: RX7s-24	



HQI-T

HQI-T/WDL 70	5200lm
HQI-T/WDL 150	13000lm
 GI2	



HQI-E / HQI-E/P

HQI-E/WDL 70	4700lm
HQI-E/WDL 100	8500lm
HQI-E/WDL 150	12000lm
HQI-E/P 250/D	17000lm
 70-150: E27, 250: E40	



CDM-RIII

CDM-RIII 35	3200lm
CDM-RIII 70	6600lm
 GX8.5	



CDM-R PAR20

PAR20 35	2000lm
 E27	



CDM-R PAR30

PAR30 35	2200lm
PAR30 70	4850lm
 E27	



Decostar TITAN

TITAN 20	320lm
TITAN 35	600lm
TITAN 50	910lm
 GU5.3	



Decostar IRC

Decostar IRC 20	400lm
Decostar IRC 35	900lm
Decostar IRC 50	1200lm
 GU5.3	



Dulux D/E

D/E 13	900lm
D/E 18	1200lm
D/E 26	1800lm
 13: GX24q-1, 18: GX24q-2 26: GX24q-3	



PL-H

PL-H 60	4000lm
PL-H 85	6000lm
PL-H 120	9000lm
 2G8-I	



Dulux F

F 36	2800lm
 2G10	



Dulux T/E IN

T/E IN 32	2400lm
T/E IN 42	3200lm
 32: GX24q-3 42: GX24q-4	



Dulux S

S 9	600lm
 GU5.3	



CFL Square 4-pin

CFL 16	1050lm
CFL 28	2050lm
CFL 38	2700lm
 GRI0q	



NEW faceted reflectors

- **Efficient** light output
- **Elegant** design
- **Latest** reflector technology

Available for:

- Cyli-Con
- Hawk
- Premium Slim / Axial / Vertical
- Premium Fighter / Fighter Axial
- Optic
- Jumbo
- Form Single / Kvadrat / Duo / Trio / Quattro
- Function DL
- Power -T
- Forte -T



SPf 12°
Spot



FLf 24°
Flood



WFLf 44°
Wideflood



VWFLf 60°
Very Wide Flood

SPf 12°	FLf 24°	WFLf 44°	VWFLf 60°
cd / 1000lm	cd / 1000lm	cd / 1000lm	cd / 1000lm
I983II25	I983II35	I983II45	I983II55

Bayonet fixing available for:

- Shop-Master
- Titium



SPf 12°
Spot



FLf 24°
Flood



WFLf 44°
Wideflood



VWFLf 60°
Very Wide Flood

SPf 12° bayonet	FLf 24° bayonet	WFLf 44° bayonet	VWFLf 44° bayonet
cd / 1000lm	cd / 1000lm	cd / 1000lm	cd / 1000lm
I983II22	I983II32	I983II42	I983II52



dynamic light



Hony HF D/E 1x18-2x26

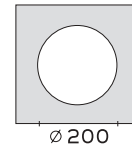
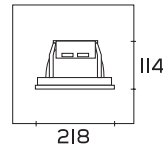
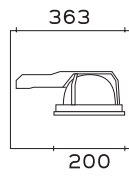

IP20/44
CL II
G24q-2
G24q-3



Dulux D/E

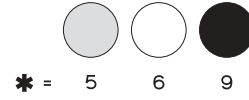

50 / pall

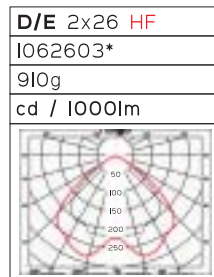
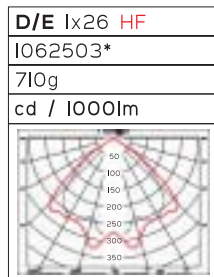
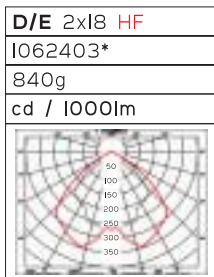
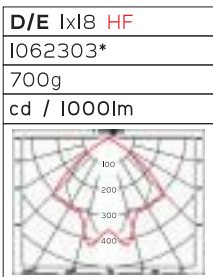

19931060 IP44



19988230



19988260





Mony HF D/E 1x18-2x26 / T/E 1x32-2x42

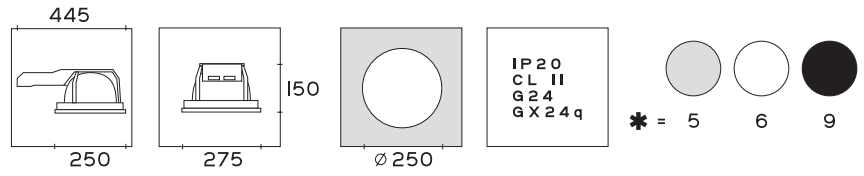

36 / pall

D/E 1x18 HF	D/E 2x18 HF	D/E 1x26 HF	D/E 2x26 HF
I075213*	I075223*	I075313*	I075323*
I350g	I490g	I360g	I530g
cd / 1000lm	cd / 1000lm	cd / 1000lm	cd / 1000lm
T/E IN 1x32 HF	T/E IN 2x32 HF	T/E IN 1x42 HF	T/E IN 2x42 HF
I079113*	I079123*	I079213*	I079223*
I380g	I570g	I400g	I700g
cd / 1000lm	cd / 1000lm	cd / 1000lm	cd / 1000lm



I9936050	I9988160
I9988120	I9988165 IP44





Partout K Dulux S 1x9-2x9

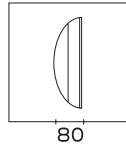
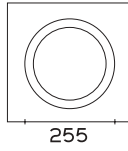

Dulux S

141 / pall

Dulux S 1x9 K
13511046
710g
cd / 1000lm

Dulux S 2x9 K
13521046
770g
cd / 1000lm





Partout II K Dulux S 1x9-2x9

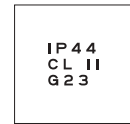
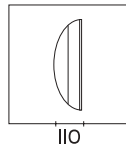
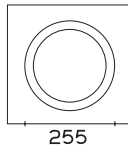

Dulux S

129 / pall

Dulux S 1x9 K
13561036
840g
cd / 1000lm

Dulux S 2x9 K
13571036
880g
cd / 1000lm





Mamy

HF Dulux D/E 26
HF CFL Square I6-28-38

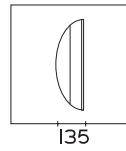
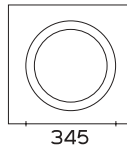

IP 20
CL II
G 24 q-3
GR10 q



Dulux D/E CFL Square

30 / pall

D/E 26 HF
I053I036
950g

CFL I6 HF
I055I036
I020g

CFL 28 HF
I056I036
I050g

CFL 38 HF
I057I036
I050g



Sunny

HF Dulux D/E I3

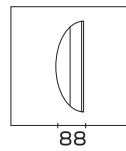
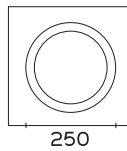

IP 20
CL II
G 24 q-I



Dulux D/E

129 / pall

D/E I3 HF
I05II036
350g
cd / 1000lm



Circus K Dulux S 2x9

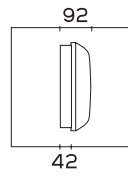
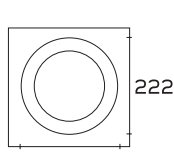

IP44
CL I
G23



150 / pall

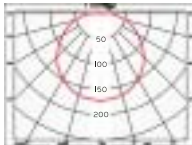

Dulux S

Dulux S 2x9 K
I332I046
830g
cd / 1000lm



Globus K Dulux F 36

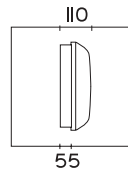
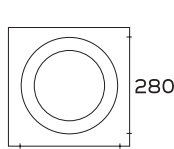

IP44
CL I
2G10



80 / pall

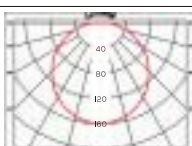

Dulux F

Dulux F 36 K
I34II046
1630g
cd / 1000lm

Practical II / IIa / I8 / I8a K Dulux S II / T12 I8

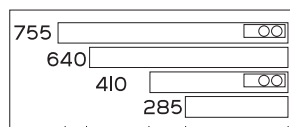
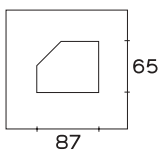

IP 21
CL II
G13
G23



I8a T12 K
R I3I4I006
L I3I4II06
I9I0g
I70 / pall



I8 T12 K
I3I3I006
I600g
I90 / pall



IIa Dulux S II K
R I3I2I046
L I3I2II46
II40g
270 / pall



II Dulux S II K
I3III046
850g
460 / pall





Trac Global Pro

XTS 4100
1000 mm
<input type="radio"/> I9104101
<input type="radio"/> I9104103
<input checked="" type="radio"/> I9104102
XTS 4200
2000 mm
<input type="radio"/> I9104201
<input type="radio"/> I9104203
<input checked="" type="radio"/> I9104202
XTS 4300
3000 mm
<input type="radio"/> I9104301
<input type="radio"/> I9104303
<input checked="" type="radio"/> I9104302
XTS 4400
4000 mm
<input type="radio"/> I9104401
<input type="radio"/> I9104403
<input checked="" type="radio"/> I9104402

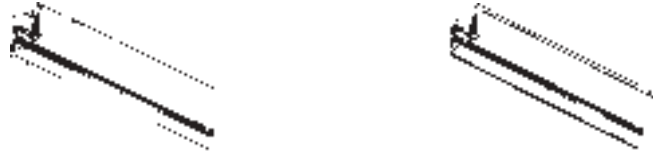

XTSF 4100
1000 mm
<input type="radio"/> I9105101
<input type="radio"/> I9105103
<input checked="" type="radio"/> I9105102
XTSF 4200
2000 mm
<input type="radio"/> I9105201
<input type="radio"/> I9105203
<input checked="" type="radio"/> I9105202
XTSF 4300
3000 mm
<input type="radio"/> I9105301
<input type="radio"/> I9105303
<input checked="" type="radio"/> I9105302
XTSF 4400
4000 mm
<input type="radio"/> I9105401
<input type="radio"/> I9105403
<input checked="" type="radio"/> I9105402

XTS II
<input type="radio"/> I9170111
<input type="radio"/> I9170113
<input checked="" type="radio"/> I9170112

XTS I2
<input type="radio"/> I9170121
<input type="radio"/> I9170123
<input checked="" type="radio"/> I9170122

XTS I4
<input type="radio"/> I9170141
<input type="radio"/> I9170143
<input checked="" type="radio"/> I9170142

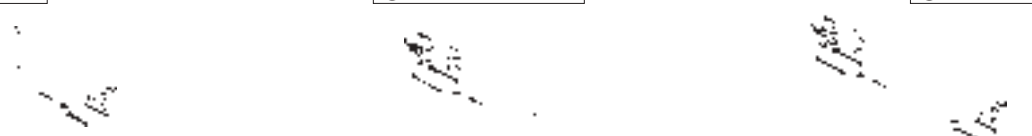

XTS 21
<input type="radio"/> I9170211
<input type="radio"/> I9170213
<input checked="" type="radio"/> I9170212

XTS 23
<input type="radio"/> I9170231
<input type="radio"/> I9170233
<input checked="" type="radio"/> I9170232

XTS 24
<input type="radio"/> I9170241
<input type="radio"/> I9170243
<input checked="" type="radio"/> I9170242



XTS 34
<input type="radio"/> I9170341
<input type="radio"/> I9170343
<input checked="" type="radio"/> I9170342
XTS 35
<input type="radio"/> I9170351
<input type="radio"/> I9170353
<input checked="" type="radio"/> I9170352

XTS 36
<input type="radio"/> I9170361
<input type="radio"/> I9170363
<input checked="" type="radio"/> I9170362
XTS 39
<input type="radio"/> I9170391
<input type="radio"/> I9170393
<input checked="" type="radio"/> I9170392

XTS 37
<input type="radio"/> I9170371
<input type="radio"/> I9170373
<input checked="" type="radio"/> I9170372
XTS 40
<input type="radio"/> I9170401
<input type="radio"/> I9170403
<input checked="" type="radio"/> I9170402

XTS 38
<input type="radio"/> I9170381
<input type="radio"/> I9170383
<input checked="" type="radio"/> I9170382



XTS 41
<input type="radio"/> I9170411
<input type="radio"/> I9170413
<input checked="" type="radio"/> I9170412

Trac Global Pro

SP 4R
F max 200N
○ I9190043
● I9190042
SP 4E
F max 100N
○ I9190133
● I9190132
SP 4I
F max 200N
○ I9190143
● I9190142
SP 4L
F max 100N
○ I9190153
● I9190152
SP 4T
F max 200N
○ I9190123
● I9190122
SP 4X
F max 200N
○ I9190113
● I9190112

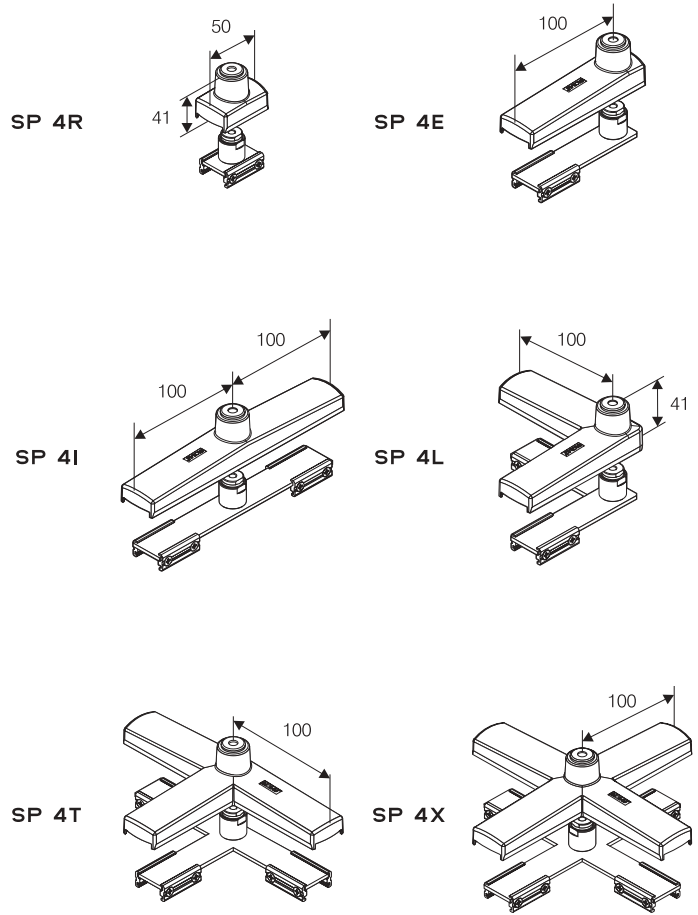

SP C16
F max 200N
∅16 mm, 1000 mm
○ I9190163
● I9190162
SP R6
F max 200N
M6, 1000 mm
○ I9190063
● I9190062
SP W1
F max 150N
M6, 1500 mm
○ I9190013
● I9190012

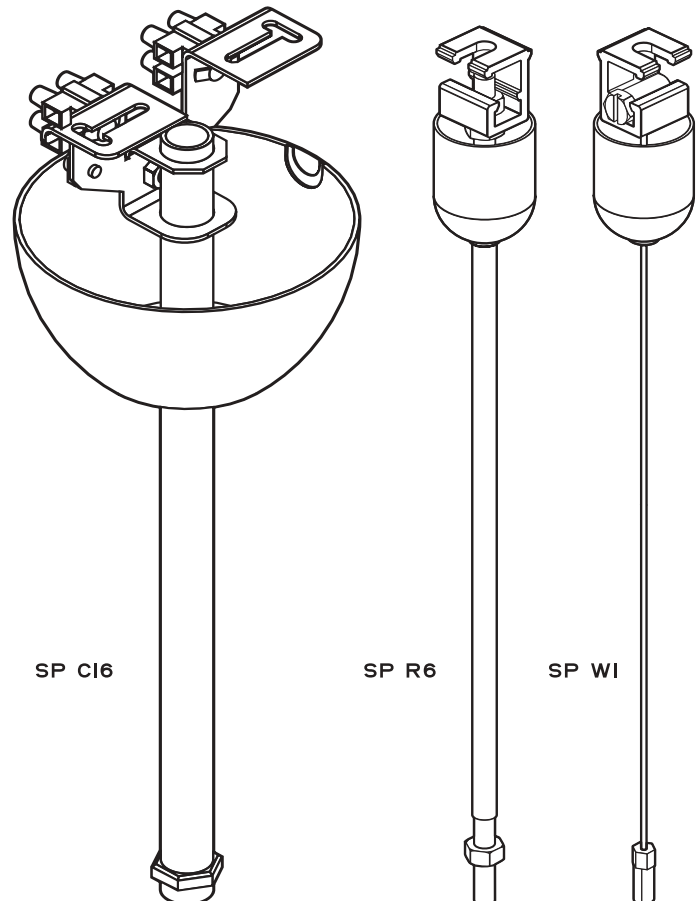

○ RAL 9010
● RAL 9005

Lival Shop-Master



● LIVAL

P.O.Box 31 04131 SIPOO Finland
Tel: +358 - 9 - 235 511
Fax: +358 - 9 - 239 3007, 239 2335
www.lival.com / lival@lival.com