



MOROSINI[®]
luce & design

4 08

MOROSINI®
luce & design

AZIENDA

MOROSINI: il nome scaturisce dalla storia di Venezia e si lega a tradizioni passate, a grandi capacità di incontrare il mondo restando sempre solidamente legati alla città lagunare.

Oggi il nome descrive una vivace azienda d'illuminazione, attenta alle evoluzioni del gusto e pronta a sperimentare nuove forme e nuovi linguaggi artistici.

Le scelte di stile di Morosini sono racchiuse nella sempre curata freschezza delle linee e nell'assoluta pulizia formale dei materiali impiegati.

Questi orientamenti trovano gratificazione nell'energia creativa di un gruppo di designer emergenti, particolarmente dediti al dare forza e valore espressivo anche a materiali insoliti, originali, non consueti al mondo dell'illuminazione.

Morosini ricalca la tradizione tecnica veneziana e ne fa elemento distintivo ed irrinunciabile: l'azienda pensa, sperimenta e produce in Italia e in Europa, a testimonianza di un orgoglio e di una sapienza costruttiva ed estetica che sono un valore in più per le lampade prodotte.

Morosini ricerca e persegue comportamenti ecocompatibili in ogni fase del processo produttivo, dalla scelta dei materiali coloranti agli imballi completamente riciclabili.

La cura per la qualità globale del lavoro è un punto d'onore e di ostinazione.

Luce e design sono i confini del territorio creativo di Morosini.

MOROSINI is the name of a noble, illustrious family intrinsically tied to the remarkable history and traditions of the republic of Venice.

It is also the name of a renowned manufacturer of lighting fixtures that pays particular attention to worldwide evolution in style, and research and development of new designs and artistic expressions.

The Morosini range of products stands in a class of its own, the result of premium materials combined with the innovative designs and skills of the company's creative group of designers who are especially dedicated to enhancing the expressive qualities of original materials rarely used in the lighting sector.

Morosini's distinctive feature is its ability in applying traditional Venetian techniques in order to experiment, design and create unique products offering added value in terms of aesthetics and style both in Italy and throughout Europe.

Morosini also pursues an eco-compatible policy in every stage of the production process – from choice of dyes to packaging materials that can be fully re-cycled.

We are proud of the great care we take in order to provide lighting fixtures offering total quality workmanship, supreme creativity and the ultimate in design.

MOROSINI[®]
luce & design

DESIGN



Andrea Lazzari



Sandi Renko

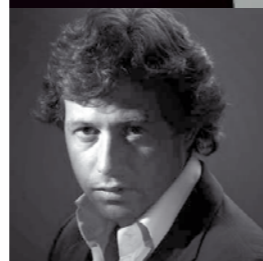

Massimo Tonetto



Stefano Cavazzana



ITlab

ALASKA60
ARES186
ASIA72
AZIMUT36
BIBLOS190
BROADWAY98
BUTTERFLY130
CLUB84
COOL64
DICE10
DRESS106
DRESS R88
DUNE160
EGG146
EYE156
EYE GLASS152
FLAT20
FLORIAN14
FOG116
FUNZIONE192
GIGLIO46
KUBIK126
MILLERIGHE42
NEMESI166
QUADRI30
ROUND52
SATURNO134
SNOW61
SPACE142
SPRING04
SUNRISE174
WAVE80
YOUNG138
ZEUS182

LAMPADINE/LEGENDA198

INDICE
INDEX



SPRING
design: Andrea Lazzari

04 SPRING



4 **Collezione di lampade in cromo, le spirali in metallo sono disponibili nelle colorazioni; cromo, bianco lucido e nero lucido, i vetri diffusori sono in vetro borosilicato (pyrex) trasparente.**

Collection of lamps in chrome, the metal spirals are available in the colours: chrome, polish white and polish black, the diffusers are in transparent pyrex glass.

Collection de lampes en chrome, les spirales en métal sont disponibles dans les couleurs: chrome, blanc brillant et noir brillant; les diffuseurs sont en verre pyrex transparent.

Kollektion von Leuchten in Chrom, die Spiralen aus Metall sind verfügbar in den Farben: chrom, weiss glänzend und schwarz glänzend; die Diffusoren sind aus Pyrex Glas transparent.

Colección de lámparas en cromo, las espirales en metal son disponibles en los colores: cromo, blanco lustroso y negro lustroso, los cristales difusores son en vidrio pyrex transparente.

Коллекция ламп из хрома, спирали в металле доступны в цветах: хром, блестящий белый и блестящий чёрный, отражательные стёкла сделаны из прозрачного стекла пирекс.

5 **SPRING/IN**

1x max 60W
G9 Halopin 



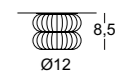

8,5

Ø12





cm 6



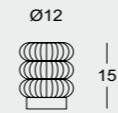

SPRING/CO Ø12
 1 x max 60W
 G9 Halopin 
 CE  IP 20

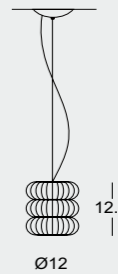

SPRING/S01
 1 x max 60W
 G9 Halopin 
 CE  IP 20



SPRING/S02
 2 x max 60W
 G9 Halopin 
 CE  IP 20

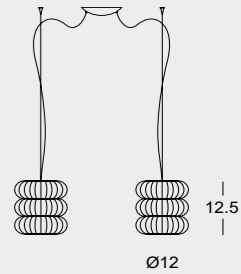

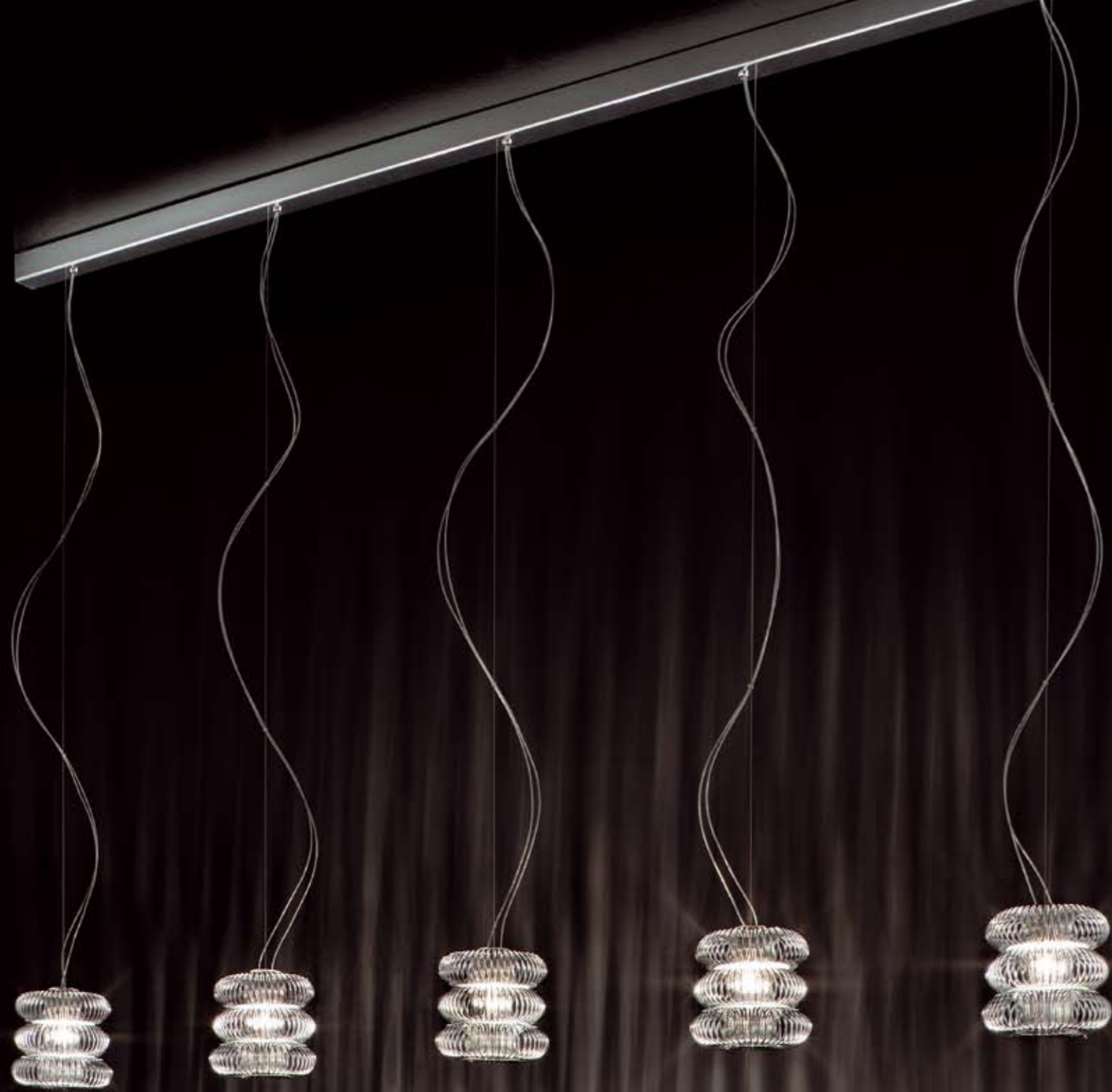

SPRING/SO

1 x max 60W
G9 Halopin

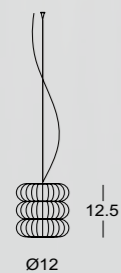

System 100 B

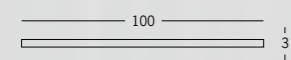

System 150 B

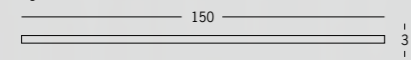

SPRING/PP

1 x max 60W
G9 Halopin

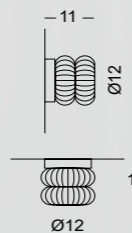

KIT SPRING/PP



Opzionale: Pyrex coprilampadina
Optional: Bulb covering in Pyrex
Optional: Bedeckung für Leuchtmittel aus Pyrex
Optional: Couverture pour ampoule en Pyrex
Opcional: Pyrex cubrebombilla
Дополнительно: Покрытие из пирекса для лампочки



DICE
design: Andrea Lazzari

010 DICE



Collezione di lampade in metallo nichel satinato, vetro extrachiaro lucido con serigrafie bianca e arancione.
Collection of lamps in metal nickel satin finish, polished extra clear glass with screen-printings white and orange.
Collection de lampes en métal nickel satiné, verre extra clair poli avec sérigraphies en couleur blanc et orange.
Colección de lámparas en metal níquel satinado, vidrio extraclaro brillante con serigrafías en blanco y arañajado.
Serie aus Metal Nickel satiniert, extra klares Glas, poliert mit Siebdrücken weiß und orange.
Коллекция ламп из серого металла алюминия, экстрасветлого блестящего стекла с белой и оранжевой сериграфией.

DICE/SO 10

1x max 60W
G9 halopin

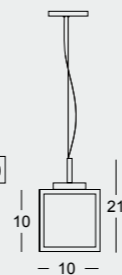

DICE/SO 10/2

2x max 60W
G9 halopin

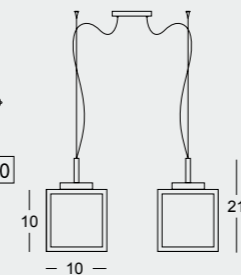

DICE/SO 20

1x max 100W

E27

o/or

1x max 100W

E27 Alo.

o/or

1x max 16W

E27 Flu.

ES

CE, F, IP 40

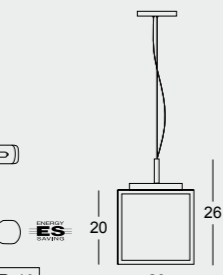

DICE/SO 20/2

2x max 100W

E27

o/or

2x max 100W

E27 Alo.

o/or

2x max 16W

E27 Flu.

ES

CE, F, IP 40

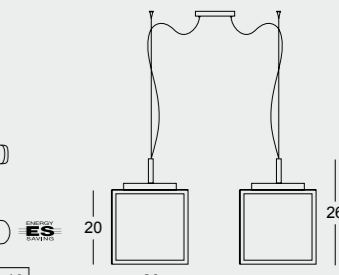



DICE/CO

1x max 60W
G9 halopin

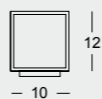

CE IP 40

DICE/TA

1x max 100W
E27
o/or
1x max 100W
E27 Alo.
o/or
1x max 16W
E27 Fluo.

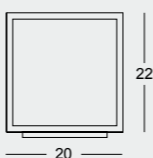

CE IP 40

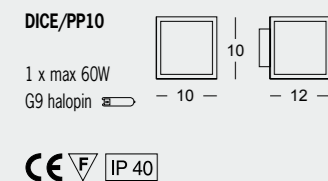
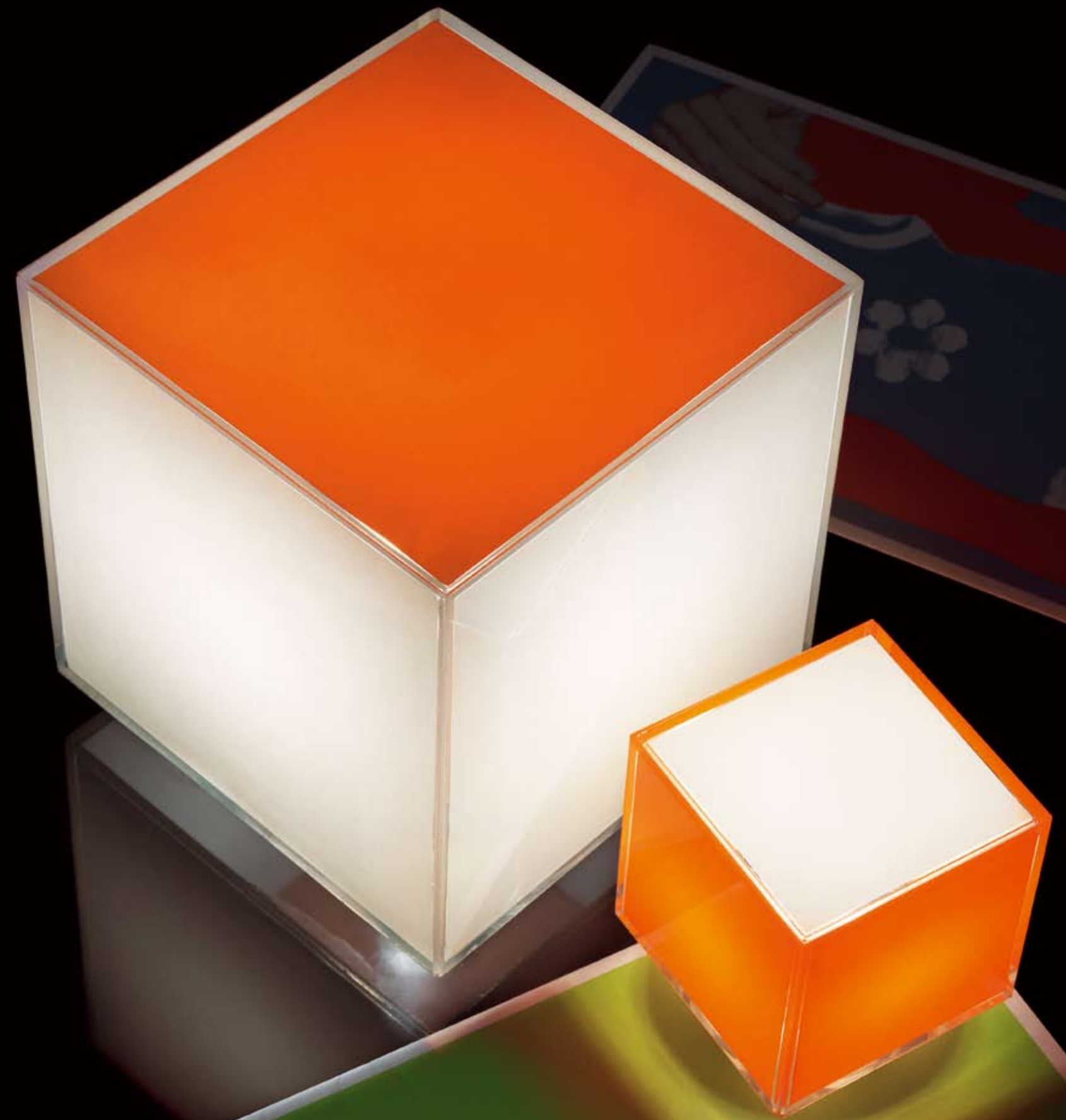

CE IP 40

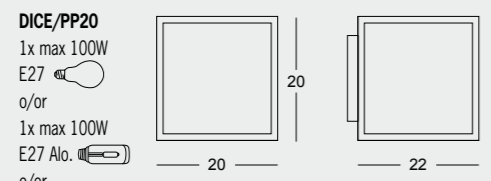

CE IP 40

Su richiesta è possibile applicare una serigrafia personalizzata.
Dice can be customized to your personal requirements using either your letters or number.
Sur demande il est possible d'appliquer une sérigraphie personnalisée.
Si lo solicita, es posible aplicar una serigrafía personalizada.
Die leuchte kann auf individuellen Wunsch (mit Nummern, Zahlen oder Piktogrammen usw) bedruckt werden.
По запросу можно нанести персонализированную серигграфию



014 FLORIAN

FLORIAN
design: Stefano Cavazzana

Collezione di lampade in metallo cromato, vetro soffiato cristallo trasparente molato con vetro diffusore interno bianco latte o con cristalli Swarovsky Strass o Spectra.
Collection of lamps in chrome-metal, transparent crystal blown glass with bevelling, inside blown glass in white milk or with crystals Swarovsky Strass or Spectra.
Collection de lampes en métal chromé, verre soufflé cristal transparent avec des meulages, verre soufflé blanc lait ou avec crystals Swarovsky Strass ou Spectra.
Colección de lámparas en metal cromado, cristal soplado transparente con biselados, con cristal difusor interior blanco leche o con cristales Swarovsky Strass o Spectra.
Serie in Chrom, mundgeblasenes Kristallglas mit Schleiferei, mundgeblasenes Glas satiniert in den Farben milchweiß oder mit Crystal Swarovsky Strass oder Spectra.
Коллекция ламп из хромированного металла, выдувного прозрачного стекла с хрустальной шлифовкой, с внутренним стеклянным отражателем молочно-белого цвета или с хрустальными Swarovsky Strass или Spectra.

FLORIAN/TA

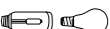

1x150W E27 alo. o/or inc. 

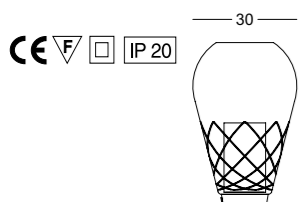
1x15W E27 PL-EL.  

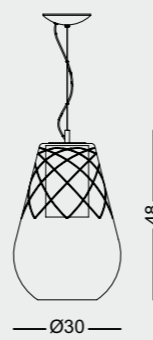





FLORIAN/SO 30

1x150W E27 alo. o/or inc. 
1x15W E27 PL-EL.  

CE  IP 20



FLORIAN/TE

1x150W E27 alo. o/or inc. 
1x15W E27 PL-EL.  

CE   IP 20



20
FLAT

FLAT/Q - FLAT/R - FLAT/PP
design: Andrea Lazzari

Q-R-PP



Collezione di lampade da parete e soffitto con diffusore in vetro extrachiaro trasparente con serigrafia nella parte centrale di colore bianco, arancione e grigio metallizzato.

Collection of wall-ceiling lamps, diffuser in extra clear glass with screen printing in the central part in white, orange or metallized grey. **The versions PP35 and PP50 are available only in the colours white, orange and mirror.**

Collection de lampes applique-plafonnier avec diffuseur en verre extra-clair sérigraphié dans la partie centrale en couleur blanc, orange ou gris métallisé. **Les versions PP35 et PP0 sont available seulement dans les couleurs: blanc, orange et miroir.**

Colección de lámparas de pared y de techo con difusor de vidrio extraclaro transparente con serigrafía en el centro de colores blanco, anaranjado y gris metalizado. **Las versiones PP35 y PP50 son disponibles solo en los colores: blanco, anaranjado y espejo.**

Serie von Wand-Decken Leuchten, Schirm aus extraklarem Glas mit Siebdruck in der Mitte in den Farben weiß, orange oder grau metallisiert. **Die Versionen PP35 und PP50 sind verfügbar nur in den Farben: weiss, orange und spiegel.**

Коллекция настенных и потолочных ламп с отражателем из прозрачного экстрасветлого стекла, с сериграфированием в середине белого цвета, оранжевого цвета и металлического серого цвета. **Версии PP35 и PP50 доступны только в цветах: белый, оранжевый и зеркальный.**



BS

GM

AR



22

FLAT/Q

1 x max 60W
G9 halopin

25 25 11

CE IP 40

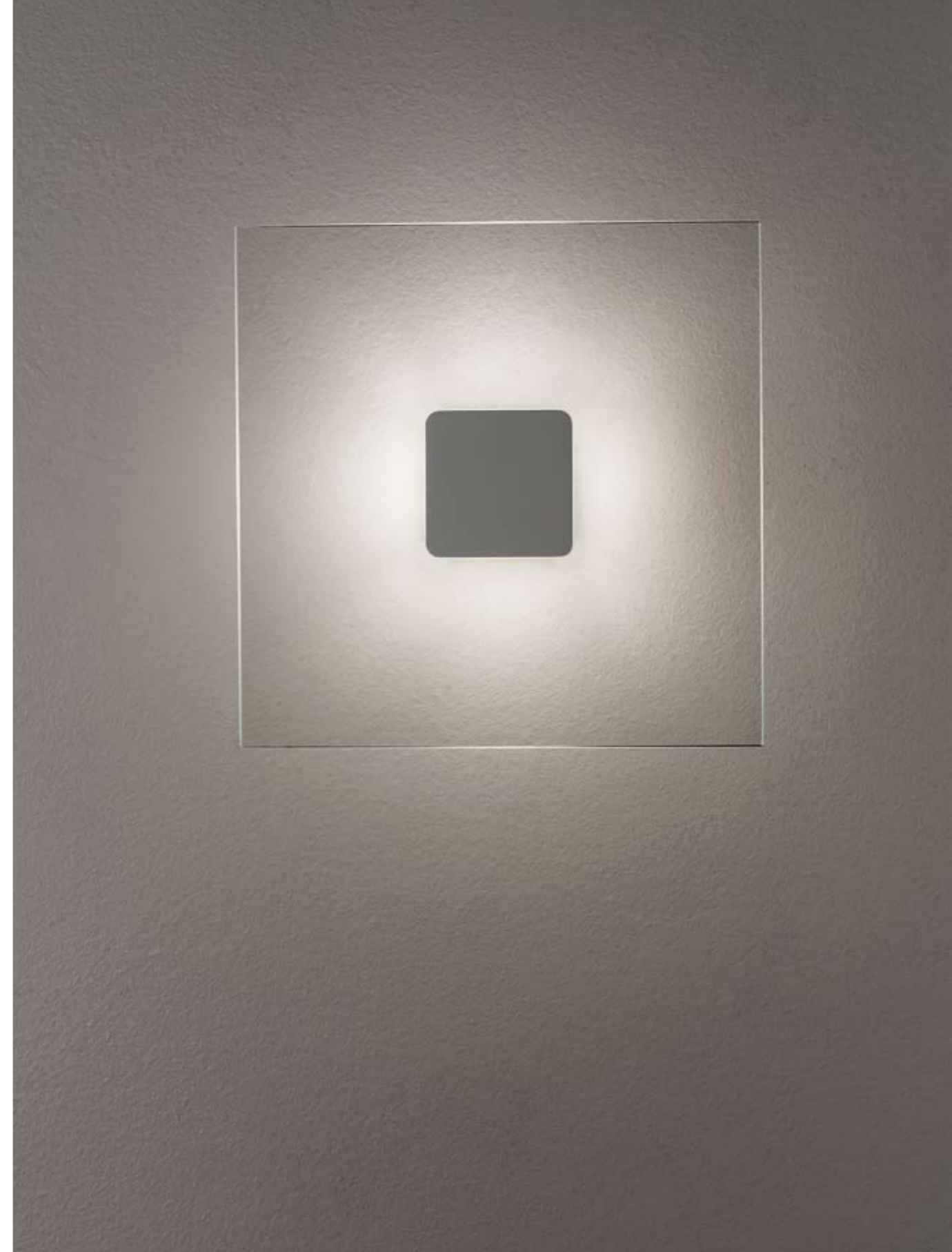

FLAT/R

1 x max 60W
G9 Halopin

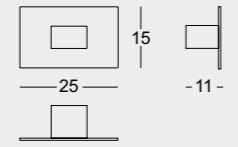

CE IP 40

FLAT/Q

1 x max 60W
G9 Halopin

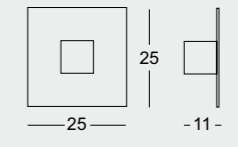

CE IP 40



BS

SP

AR



FLAT/PP 35 E

2 x MAX 24W
2G11 FLUO

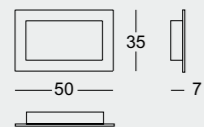

CE F IP 40 ENERGY SAVING ES

E-ballast elettronico/Electronic ballast



FLAT/PP 50 E

2 x MAX 24W
2G11 FLUO

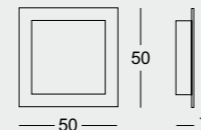
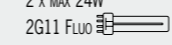

E-ballast elettronico/Electronic ballast

30 QUADRI

Collezione di lampade in alluminio lucido o satinato, vetro bianco latte satinato con molature serigrafate cristallo o decoro micro quadri.
Collection of lamps in aluminium polish or satin finish, satin finished white milk glass with crystal screen-printed bevelling or with "micro squares" decoration.
Collection de lampes en aluminium poli ou satiné, verre satiné blanc lait avec des meulages cristal sérigraphiés ou avec décoration "micro carreaux".
Colección de lámparas en aluminio lucido o satinado, cristal satinado blanco leche con biselados serigrafados cristal o con decoración "micro cuadrados".
Serie in aluminium poliert oder satiniert, milchweißes Glas satiniert mit Kristall Schleiferei Siebdruck oder mit Dekoration „mikro kariert“.
Коллекция ламп из блестящего или сатинированного алюминия, молочно-белого сатинированного стекла с сериграфированной хрустальной шлифовкой или с декорацией "микро квадраты".





QUADRI/PP 43
4x max 40W
G9 halopin

QUADRI/PP 43 E
2x18W
2G11 fluo. 
E-ballast elettronico/Electronic ballast

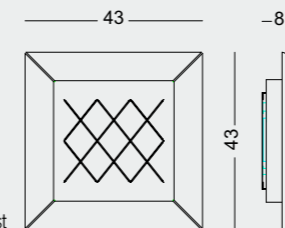

CE  IP 20

QUADRI/PP 58
4x max 60W
G9 halopin

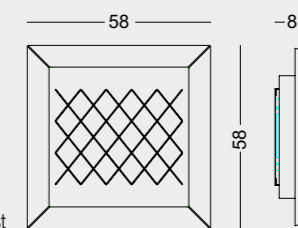

QUADRI/PP 58 E
2x24W
2G11 fluo. 
E-ballast elettronico/Electronic ballast



CE  IP 20





QUADRI/PP 43
 4x max 60W
 G9 Halopin 

QUADRI/PP 43 E
 2x24W
 2G11 fluo.  
 E-ballast elettronico/Electronic ballast

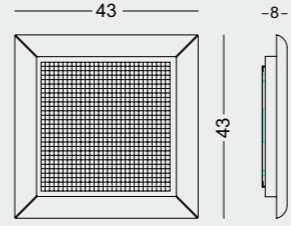
CE  IP 20



QUADRI/PP 58
 4x max 60W
 G9 Halopin 

QUADRI/PP 58 E
 2x24W
 2G11 fluo.  
 E-ballast elettronico/Electronic ballast

CE  IP 20

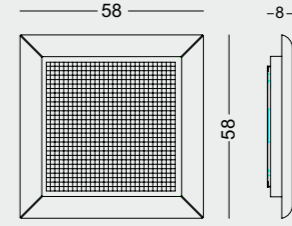

36 AZIMUT

AZIMUT

design: Andrea Lazzari e Massimo Tonetto

Collezione di lampade in metallo acciaio inox satinato o metacrilato nei colori giallo, arancione, nero, vetro soffiato bianco latte con finitura satinata.
Collection of lamps in metal satin-finished stainless steel. Frame also in methacrylate black, orange or yellow, milk white blown glass with satin finish.
Collection de lampes en métal acier inox satiné. Structure aussi en méthacrylate noir, orange ou jaune, verre soufflé blanc lait avec finition satinée.
Colección de lámparas en metal acero inox satinado. Armazón también en metacrilato negro, anaranjado o amarillo, cristal soplado blanco leche, acabado satinado.
Serie aus Stahl Inox satiniert. Struktur verfügbar auch aus Methacrylat in den Farben gelb, orange oder schwarz, mundgeblasenes milchweiße Glas mit satinierter Ausführung.
Коллекция ламп из нержавеющей сатинированной стали или метакрилата в желтом, оранжевом, черном цвете, из выдувного стекла белого молочного цвета с сатинированной отделкой.



AZIMUT/CO

1x max 75W
G9 halopin

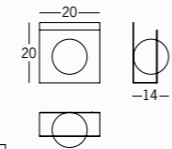

CE IP 40

AZIMUT/PA2

2x max 75W
G9 halopin

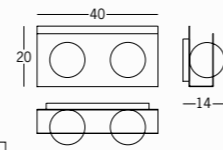

CE IP 40

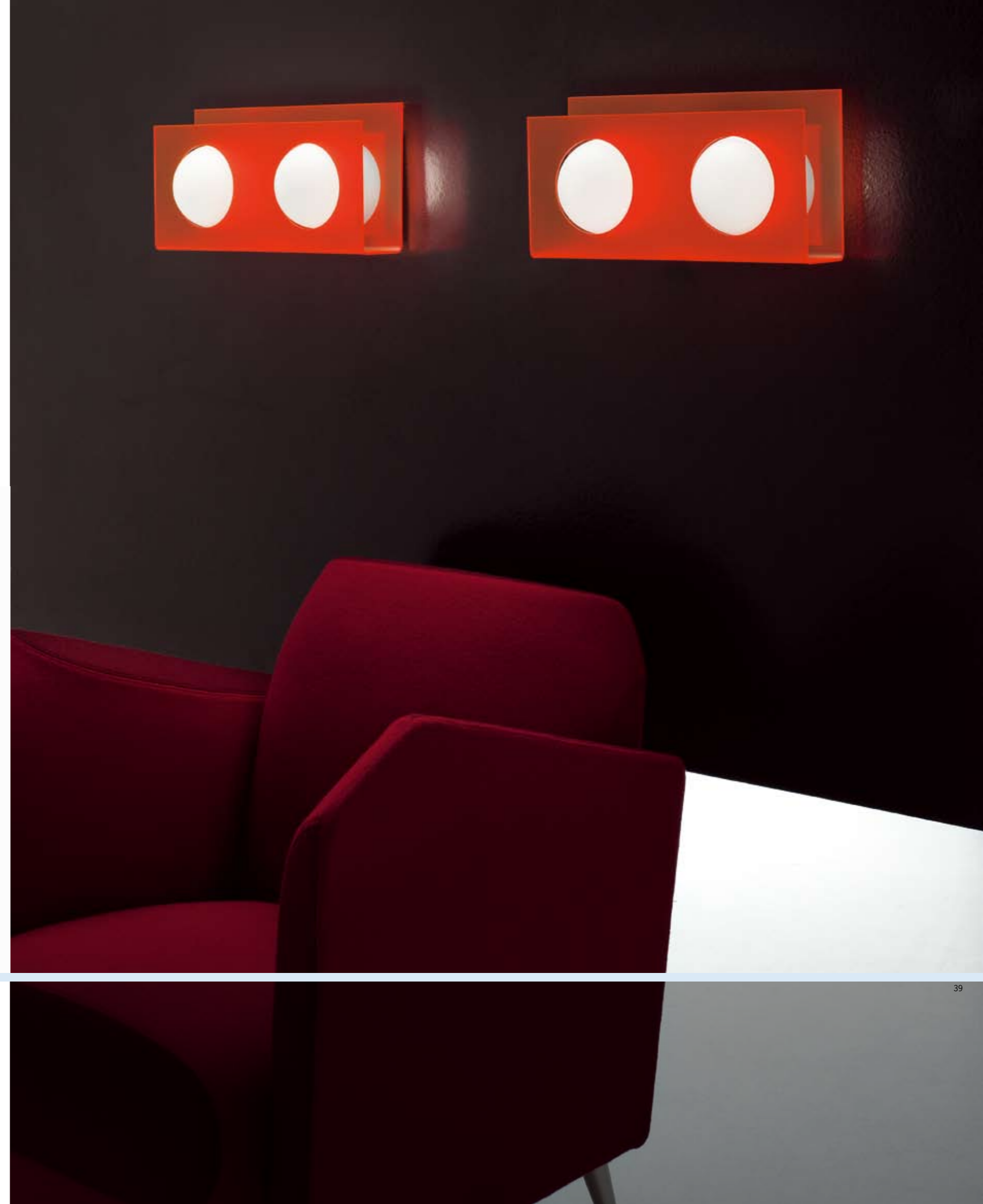



AZIMUT/PA1

1x max 75W
G9 halopin

CE V IP 40

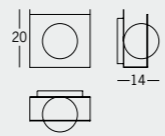

AZIMUT/PL

4x max 75W
G9 halopin

CE V IP 40

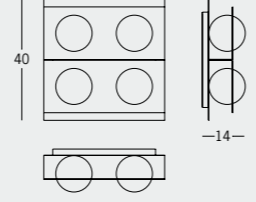

42 MILLERIGHE

MILLERIGHE
design: Sandi Renko

Collezione di lampade in metallo cromato, vetro pirex ottico lucido esterno e specchiato interno.

Collection of lamps in chrome-metal, optical pirex glass polished outside and looking-glass inside.

Collection de lampes en métal chromé, verre pirex optique avec finition polie à l'extérieur et miroir-reluisant à l'intérieur.

Colección de lámparas en metal cromado, cristal pirex optico brillante externo y espejado interno.

Serie aus Metall Chrom, optisches pirex Glas außen poliert und innen spiegelblank.

Коллекция ламп из хромированного металла, оптическое стекло пирекс, блестящее снаружи и зеркальное внутри.

MILLERIGHE/SO 1
SOLO - ONLY
1x max 100W
E27 Inc.

CE  IP 20

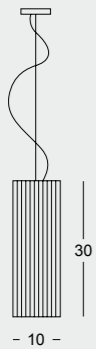

- 10 -

MILLERIGHE/SO 2
SOLO - ONLY
2x max 100W
E27 Inc.

CE  IP 20

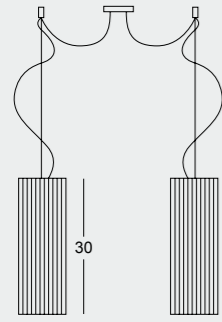

- 10 -



46 GIGLIO

GIGLIO

design: Andrea Lazzari e Massimo Tonetto

46

Collezione di lampade in metallo cromato, vetro soffiato cristallo trasparente e vetro soffiato bianco latte con molature cristallo, finitura satinata.

Collection of lamps in chrome-metal, blown crystal transparent glass and milk white blown glass with bevelling in crystal, satin finish.

Collection de lampes en métal chromé, verre soufflé cristal transparent et verre soufflé blanc lait avec des meulages en cristal, finition satinée.

Colección de lámparas en metal cromado, cristal soplado transparente y cristal soplado blanco leche con biselados cristal, acabado satinado.

Serie in Chrom, mundgeblasenes Kristallglas und mundgeblasenes milchweiße Glas mit Kristallchliff, satiniert

Коллекция ламп из хромированного металла, выдувного прозрачного стекла молочно-белого цвета с хрустальной шлифовкой и сатирированной отделкой.

Giglio PA Lampada da parete in metallo cromato, vetro extrachiaro serigrafato bianco con finitura lucida.

Wall lamp in chrome-metal, extra clear glass with white screen printing, satin finish.

Applique en métal chromé, verre extra-clair sérigraphié blanc, finition satinée.

Applique en metal cromado, cristal extraclaro serigrafado blanco, acabado satinado.





Wandleuchter in Chrom, Glas extraklar mit Siebdruck weiß, satiniert.

Настенная лампа из хромированного металла, сериграфированное экстрасветлое стекло с блестящей отделкой.

47





GIGLIO/TE

- 1 x max 250W
E27 Alo. 
- o/or
- 1 x max 200W
E27 Inc. 
- o/or
- 1 x max 23W
PL-EL.  

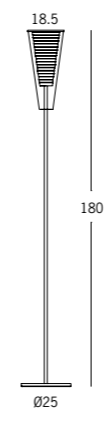
CE   IP 20



GIGLIO/PA

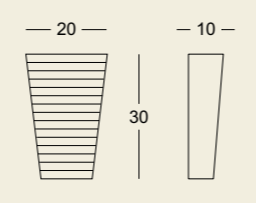

- 1x max 100W
E27 inc. 
- o/or
- 1 x max 20W
E27 PL-EL.  

CE   IP 20







GIGLIO/S0

1 x max 150W
E27 Inc. o Alo. 
o/or
1 x max 23W
E27 PL-EL. 

CE  IP 20



GIGLIO/S02

2 x max 150W
E27 Inc. o Alo. 
o/or
2 x max 23W
E27 PL-EL. 

CE  IP 20

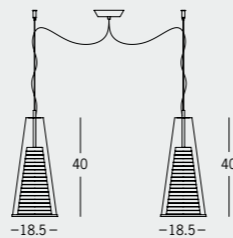

52 ROUND

ROUND

design: Andrea Lazzari e Massimo Tonetto

Collezione di lampade in metallo cromato o nichel satinato, vetro soffiato bianco latte satinato o rosso satinato. Disponibile con lente in vetro satinato.

Collection of lamps in chrome-metal or satin finished nickel, blown glass milk white or red, satin finish. **Available with satin finished glass lens.**

Collection de lampes en métal chromé ou nickel satiné, verre soufflé blanc lait ou rouge, finition satinée. **Disponible avec lentille en verre satiné.**

Colección de lámparas en metal cromado o níquel satinado, cristal soplado blanco leche o rojo acabado satinado. **Disponible con lente en cristal satinado.**

Serie in Chrom oder Nickel satiniert, mundgeblasenes Glas milchweiß oder rot, satiniert. **Auch verfügbar mit Linse aus satiniertem Glas.**

Коллекция ламп из хромированного металла или сатирированного никеля, выдувное стекло молочно-белого или красного сатирированного цвета.

Предоставляется с линзой из сатирированного стекла.



ROUND/SO 35

1x max 150W
E27 Alo.

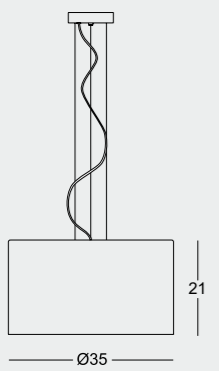

ROUND/SO 15

1x max 75W
G9 Halopin

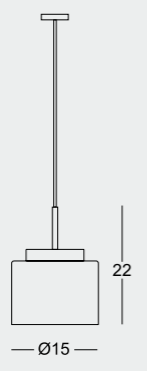

ROUND/SO 15 S

1x max 75W
G9 Halopin

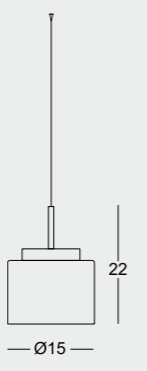

System 100 A

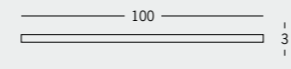

System 150 A

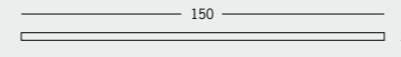





ROUND/PL

1x max 150W E27 Alo. 

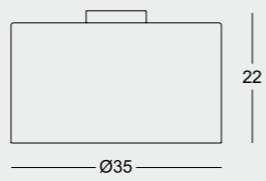
CE  **IP 20**



ROUND/TA

1x max 150W
E27 Alo. 

CE   **IP 20**

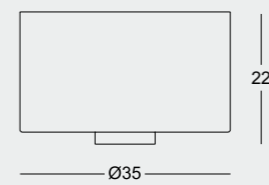



ROUND/CO

1x max 60W
G9 Halopin

CE F IP 20

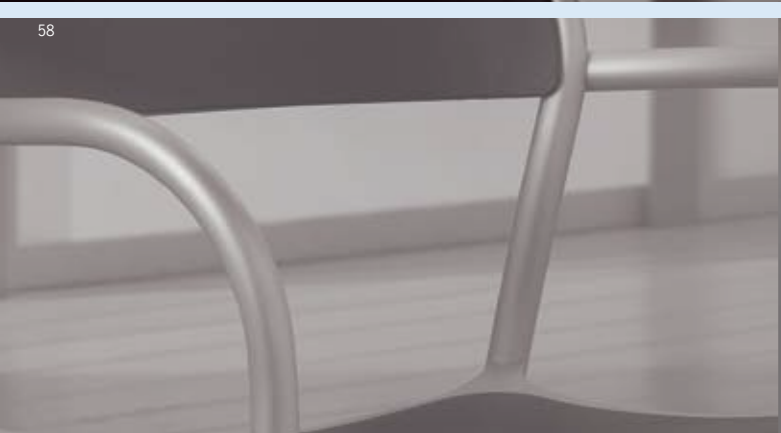

ROUND/PP

1x max 60W
G9 Halopin

CE F IP 20

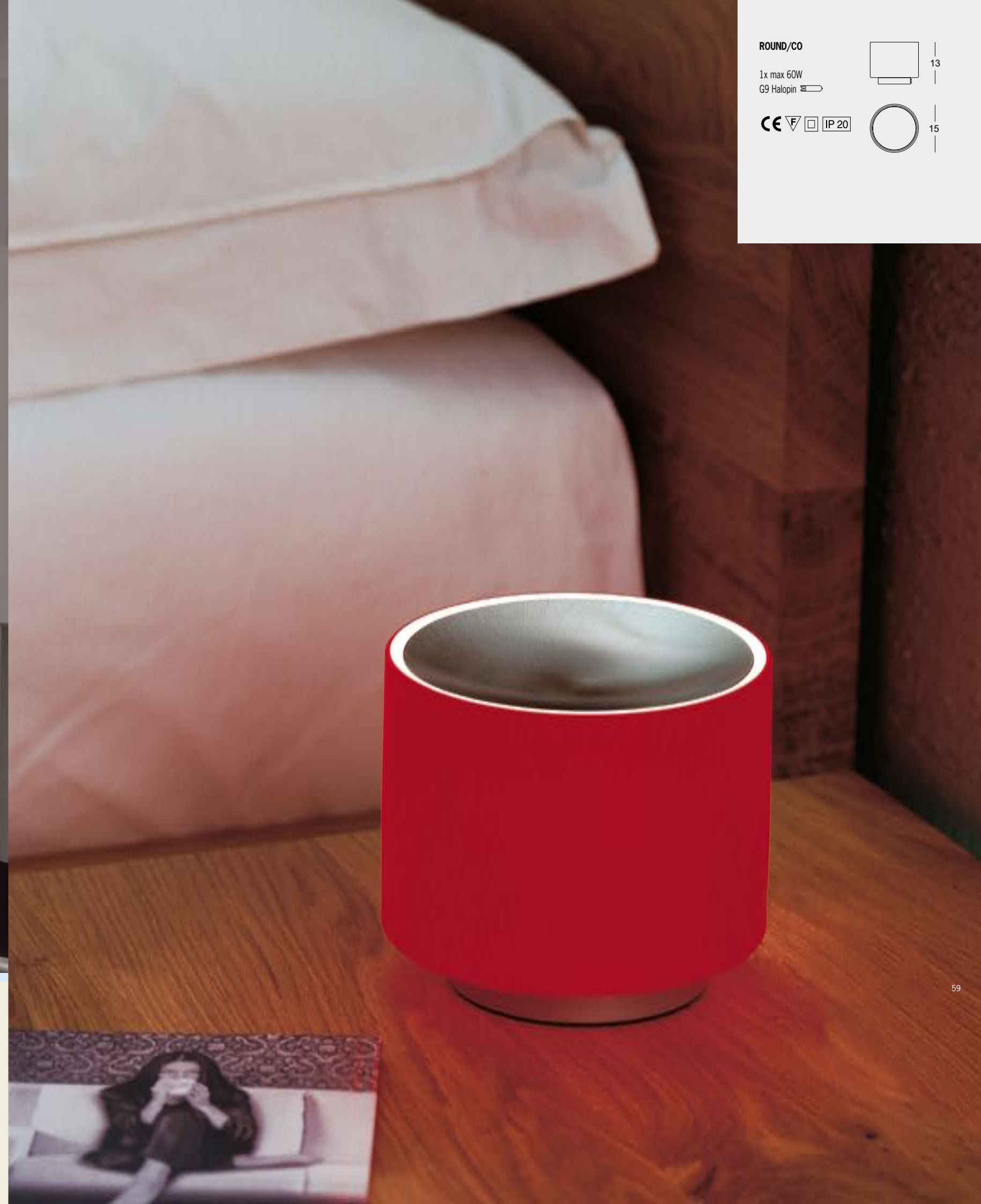

60 ALASKA

SNOW
design: Ufficio Stile

ALASKA
design: Ufficio Stile

61 SNOW

Collezione di lampade da parete e soffitto in vetro soffiato bianco latte lucido con bordo in cristallo trasparente.
Collection of wall-ceiling lamps, milkwhite blown glass polished finish with transparent crystal edge.
Collection de lampes applique-plafonnier, diffuseur en verre soufflé blanc lait finition brillante avec bord en cristal transparent.
Colección de lámparas de pared y de techo, de vidrio soplado blanco leche brillante con borde de cristal transparente.
Serie von Wand-Decken Leuchten, Schirm aus mundgeblasenem glänzenden milchweißen Glas mit Bord aus Klar-kristallglas.
Коллекция настенных и потолочных ламп из молочно-белого блестящего выдувного стекла с кромкой из прозрачного хрустала

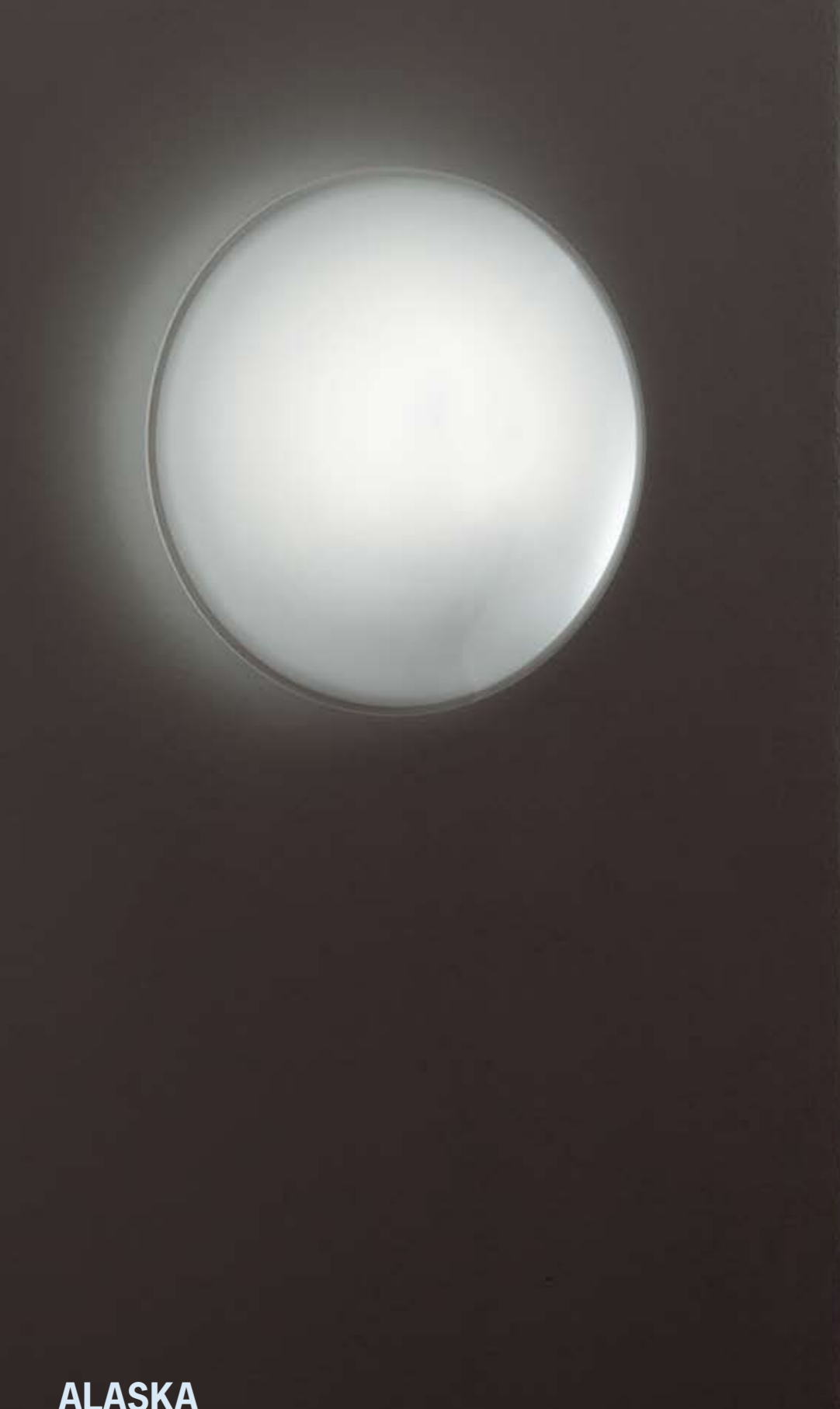

Collezione di lampade da parete e soffitto in vetro soffiato bianco latte satinato.
Collection of wall-ceiling lamps, milkwhite blowingglass, satin finish.
Collection de lampes applique-plafonnier, diffuseur en verre soufflé blanc lait, finition satinée.
Colección de lámparas de pared y de techo, de vidrio soplado satinado blanco leche.
Serie von Wand-Decken Leuchten, Schirm aus mundgeblasenem milchweißen Glas, satiniert.
Коллекция настенных и потолочных ламп из выдувного стекла молочно-белого цвета, сатинированного.





ALASKA



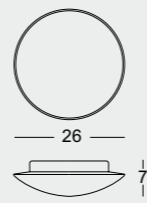

SNOW-ALASKA/PP 26
1 x max 60W
E27 inc. 

  





SNOW-ALASKA/PP 38
2 x max 60W
E27 inc. 

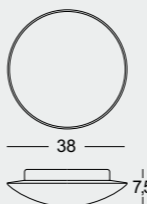

SNOW-ALASKA/PP 44
3 x max 60W
E27 inc. 



SNOW

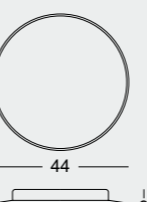

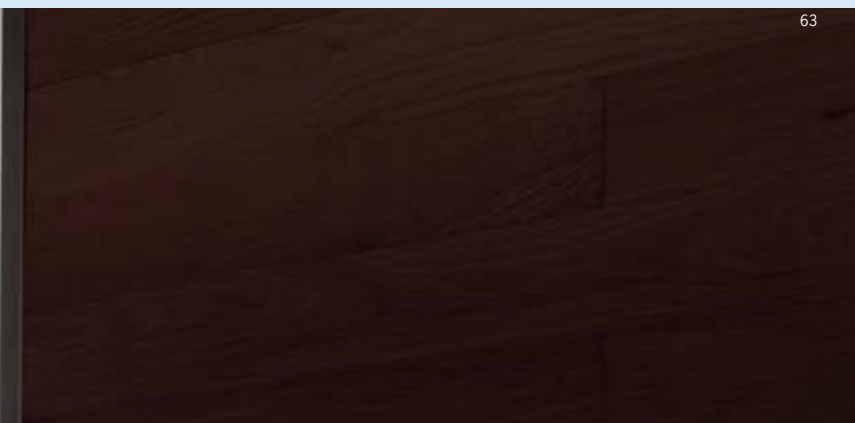
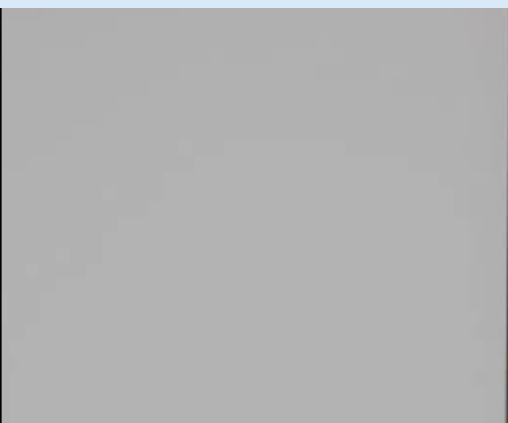
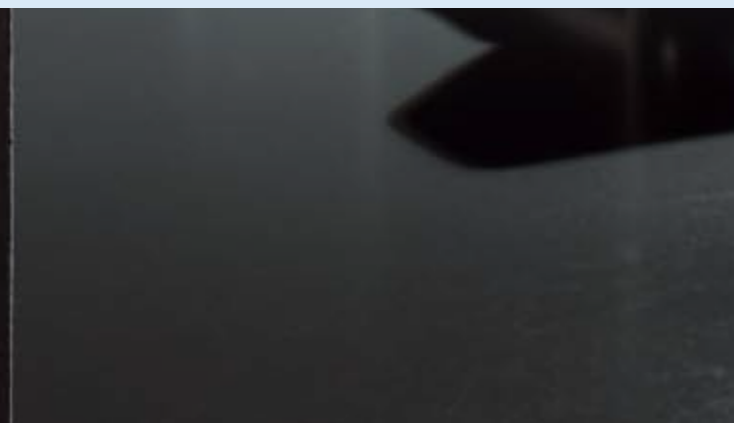
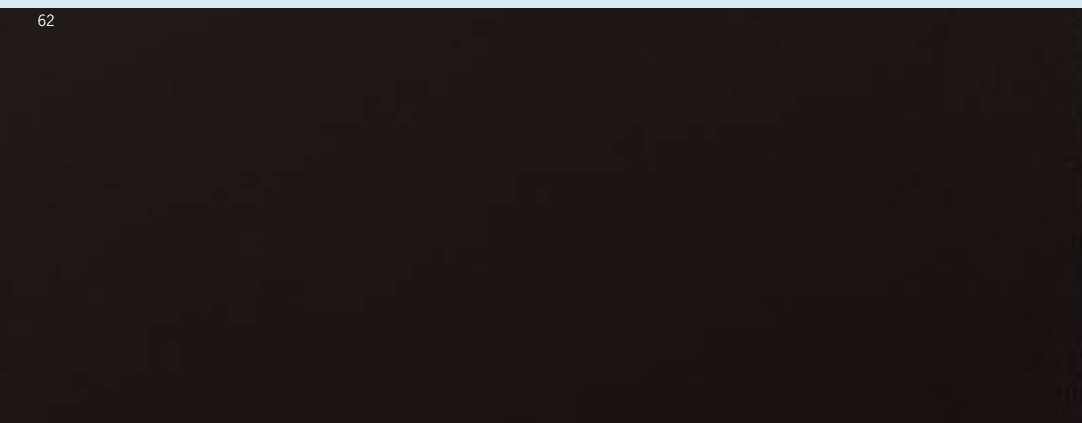
64 COOL

COOL
design: Andrea Lazzari

Collezione di lampade in vetro nero lucido, rosso lucido e specchio, vetro soffiato bianco latte con finitura satinata.
Collection of lamps in glass in colours polished black, red or mirror, milk white blown glass, satin finish.
Collection de lampes avec diffuseur en verre poli noir, rouge ou miroir, verre soufflé blanc lait, finition satinée.
Colección de lámparas en vidrio de colores lucido negro, rojo o espejo, cristal soplado blanco leche, acabado satinado.
Serie mit Schirm aus Glas in den Farben schwarz, rot oder spiegel, mundgeblasenes milchweiße Glas, satiniert.
Коллекция ламп из стекла черного блестящего, красного блестящего цвета и зеркала, выдувного стекла молочно-белого цвета с сатирированной отделкой.



COOL/PL

4x max 60W
G9 Halopin

CE  IP 40

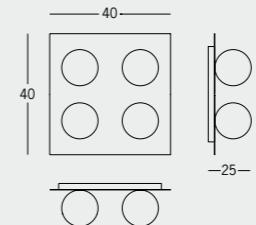

COOL/CO

1x max 60W
G9 Halopin

CE   IP 40

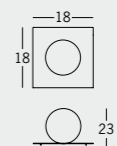



COOL/PA2

2x max 60W
G9 Halopin

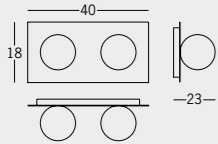

CE IP40

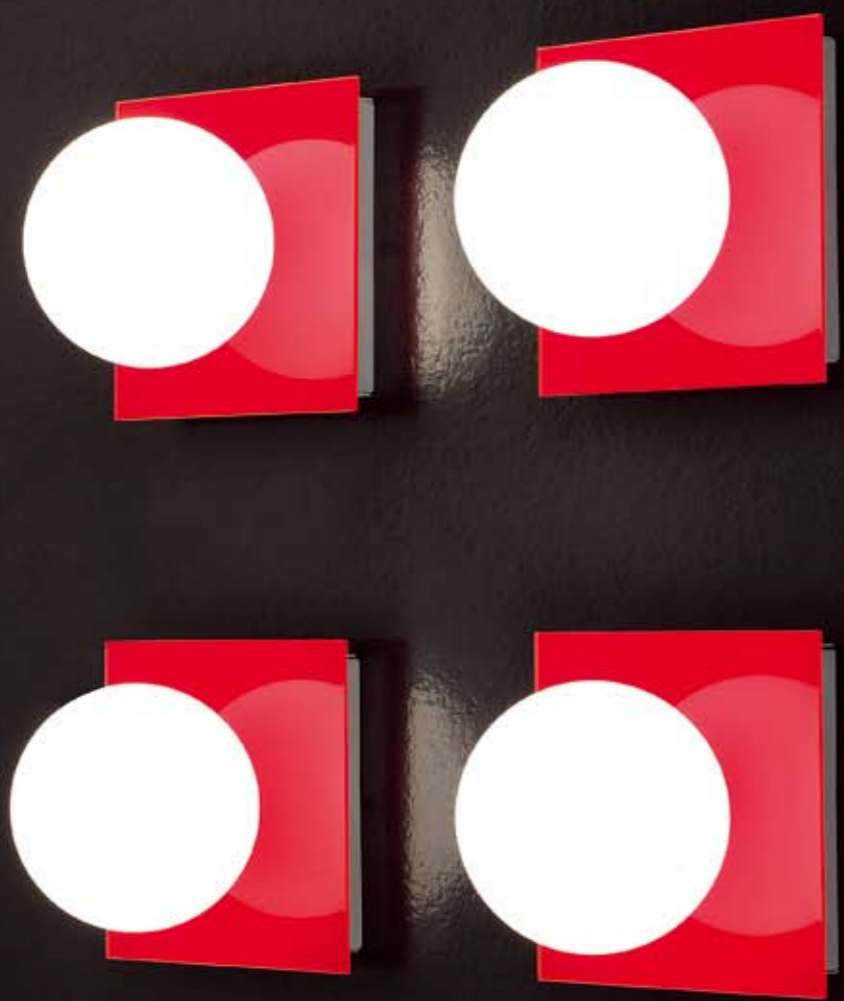

COOL/PA3

3x max 60W
G9 Halopin

CE IP 40

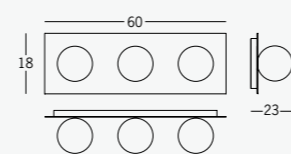

COOL/PA 1

1x60W G9 Halopin

CE IP 40

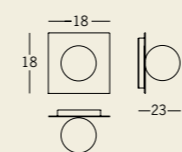

72 ASIA

ASIA

design: Andrea Lazzari e Massimo Tonetto

Collezione di lampade in metallo cromato, con doppio vetro soffiato bianco e nero, finitura lucida. La sospensione è disponibile con entrambe i vetri bianchi.

Collection of lamps in chrome-metal, with double white and black blown glass, polished finish.

The suspension is available with both glasses in white.

Collection de lampes en métal chromé, avec double verre soufflé blanc et noire, finition brillante.

Les deux verres de la suspension sont disponibles en blanc.

Colección de lámparas en metal cromado, con doble cristal soplado blanco y negro, acabado lucido.

La suspensión está disponible con ambos cristales en blanco.

Serie aus Metall Chrom mit doppeltem mundeblasenen Glas weiß und schwarz mit glänzender Ausführung. Die Hängelampe ist auch verfügbar mit beiden Gläsern in weißer Farbe.

Коллекция ламп из хромированного металла, с двойным выдувным белым и черным стеклом и блестящей отделкой. Подвеска предоставляется с обеими белыми стеклами.



ASIA/TE

1 x max 250W

E27 Alo. 



o/or

1 x max 200W

E27 Inc. 

o/or

1 x max 23W

E27 PL-EL.  

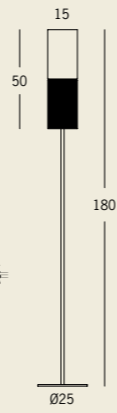

ASIA/SO

1 x max 15 0W

E27 Inc. o A lo. 



+

1 x max 50 W

Gu10 

o/or

1 x max 23 W

PL-EL.  

+

1 x max 50 W



GU10 

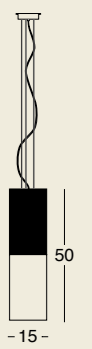





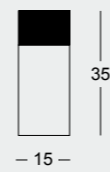

ASIA/PL

1 x max 150W
E27 Inc. o Alo. 
o/or
1 x 23W
E27 PL-EL. 



  

ASIA/CO

1 x max 150W
E27 Inc. o Alo. 
o/or
1 x max 23W
E27 PL-EL. 



  

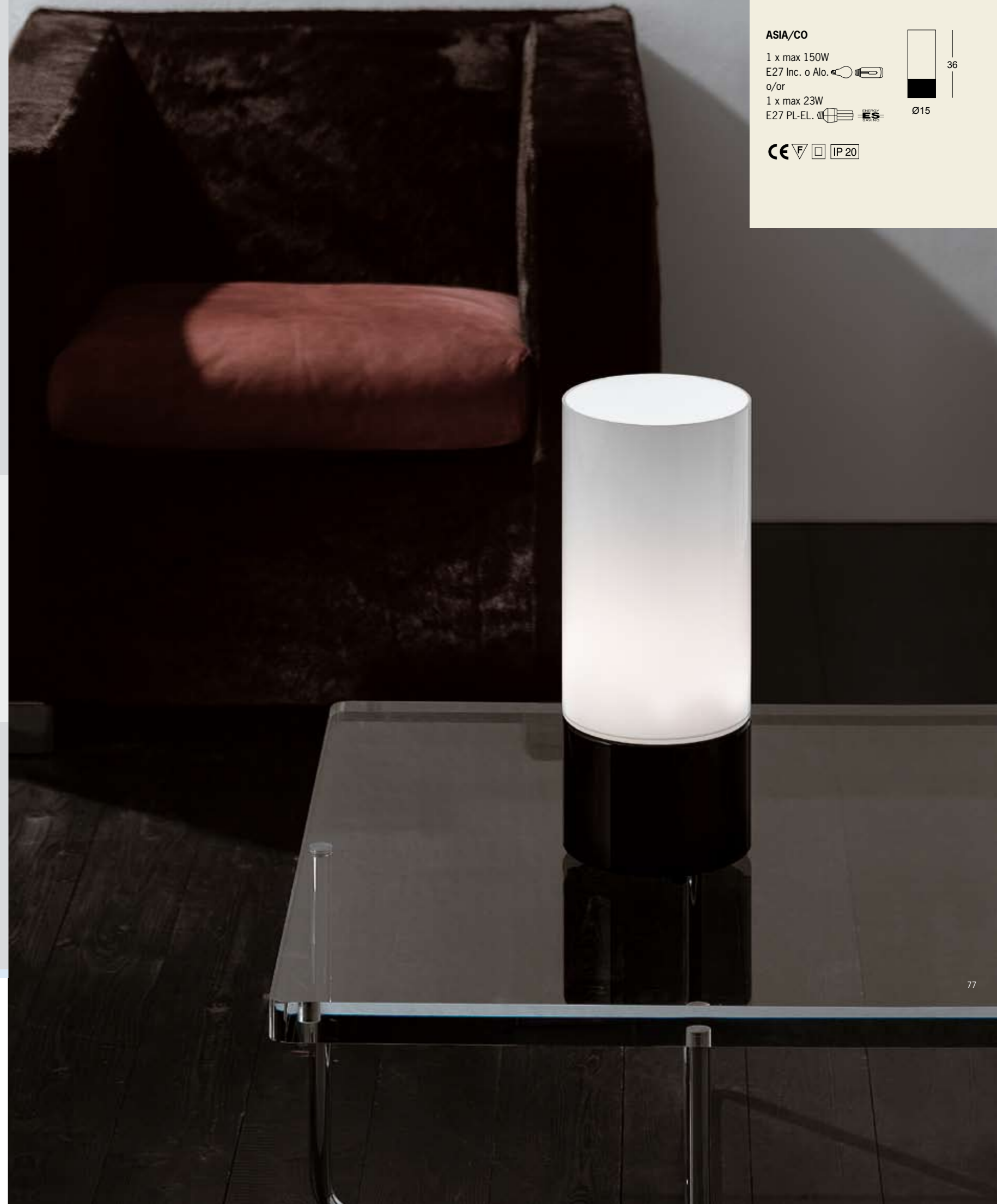



ASIA/PA

2 x max 60W
G9 Halopin

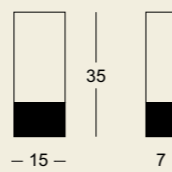

- 15 -

7

ASIA/SO White

2 x max 100W
E27
or
2 x max 23W
E27 PL-EL

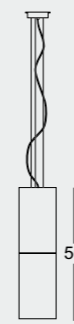

- 15 -



80 WAVE

WAVE
design: Ufficio Stile



Collezione di sospensioni in metallo cromato o nichel satinato, vetro pressato disponibile nei colori bianco latte satinato, rosso satinato e grigio metallizzato.

Collection of suspensions in chrome-metal or satin finished nickel, pressed glass available in satin finished milk white, satin finished red or grey aluminium.

Collection de suspensions en métal chromé ou nickel satiné, verre pressé disponible en blanc lait satiné, rouge satiné ou gris aluminium.

Colección de suspensiones en metal cromado o niquel satinado, cristal prensado disponible en blanco leche satinado, rojo satinado o gris aluminio.

Serie von Hängelampen in Chrom oder Nickel satiniert, gepresst Glas erhältlich in den Farben milchweiß satiniert, Rot satiniert oder aluminium grau.

Коллекция подвесок из хромированного металла или сатирированного никеля, прессованное стекло предоставляется молочно-белого сатирированного цвета, красного сатирированного и серого металлизированного.

WAVE/S0 50

1 x max 150W
E27 inc.

CE  IP 20

o/or

1 x max 21W
E27 PL-EL

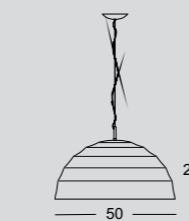

 ES



WAVE/SO 50

1 x max 150W
E27 inc.

CE F IP 20

o/or
1 x max 21W
E27 PL-EL

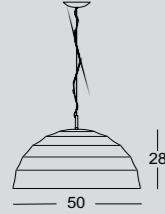

84 CLUB

CLUB

design: Andrea Lazzari e Massimo Tonetto

Collezione di lampade in legno Wengé, Zebrano o con finitura alluminio, vetro extrachiaro serigrafato bianco con finitura satinata.

Collection of lamps in Wengé or Zebrano wood or in aluminium finish; extra clear glass with white screen printing, satin finish.
Collection de lampes en bois Wengé ou Zebrano ou avec finition aluminium, verre extra-clair sérigraphié blanc, finition satinée.
Colección de lámparas en madera Wengé o Zebrano o acabado Aluminio, cristal extraclaro serigrafado blanco, acabado satinado.

Serie aus Holz Wengé oder Zebrano oder mit aluminium Ausführung, extraklares Glas mit weißen Siebdruck, satiniert.
Коллекция ламп из древесины Венге, зебрано или с алюминиевой отделкой, экстрасветлым стеклом с белой сериграфией с сатирированной отделкой.

CLUB 30/PP

4 x max 40W
G9 Halopin



CLUB 30/PP E

2 x max 18W
2G11 Fluor.

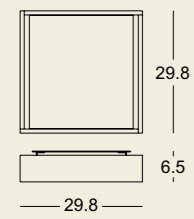
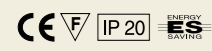

E-ballast elettronico/Electronic ballast

CLUB 40/PP

4 x max 60W
G9 Halopin



CLUB 40/PP E

2 x max 24W
2G11 Fluor.

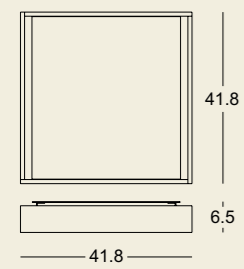
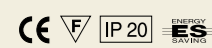

E-ballast elettronico/Electronic ballast



CLUB 20/PP

2 x max 40W
G9 Halopin

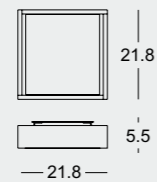

DRESS R

design: Andrea Lazzari

88 DRESS R

DRESS R

Collezione di lampade in acciaio inox satinato, diffusore in tessuto metallico, colore silver, rosso e avorio.

Collection of lamps in satin finished stainless steel, metal fabric diffuser in the colours silver, red and ivory.

Collection de lampes en acier inox satiné, diffuseur en tissu métallique dans les couleurs silver, rouge et ivoire.

Colectión de lámparas en acero inox satinado, difusor en tejido metálico, color silver, rojo y marfil.

Serie in Stahl Inox satiniert, Schirm aus Metallgewebe in den Farben silver, rot und elfenbein.

Коллекция ламп из сатирированной нержавеющей стали, отражатель из металлической ткани серебряного цвета, красного цвета и цвета слоновой кости.



DRESS R/PA 40

2 x 60W E27 incand. 

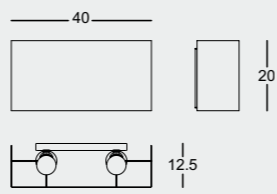

   IP 20



DRESS R/TE

3 x 60W E27 incand. 

o/or

3 x 20W E27 PL-EL.  

   IP 20

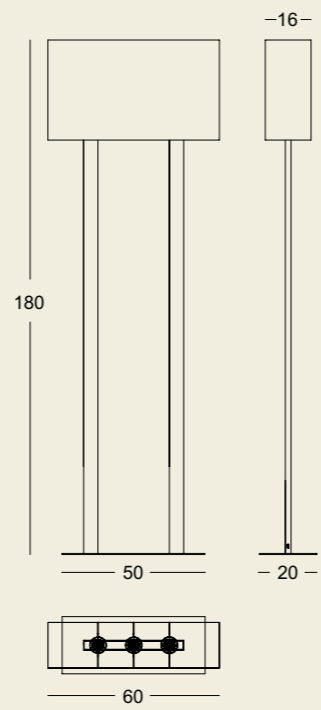



select

50
2000
HIGH IN
CYBER

92

DRESS R/CO

2 x 40W E14 incand.

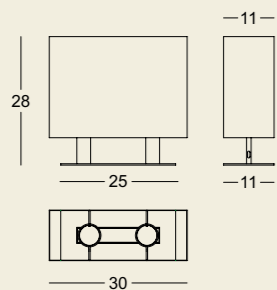

CE IP 20

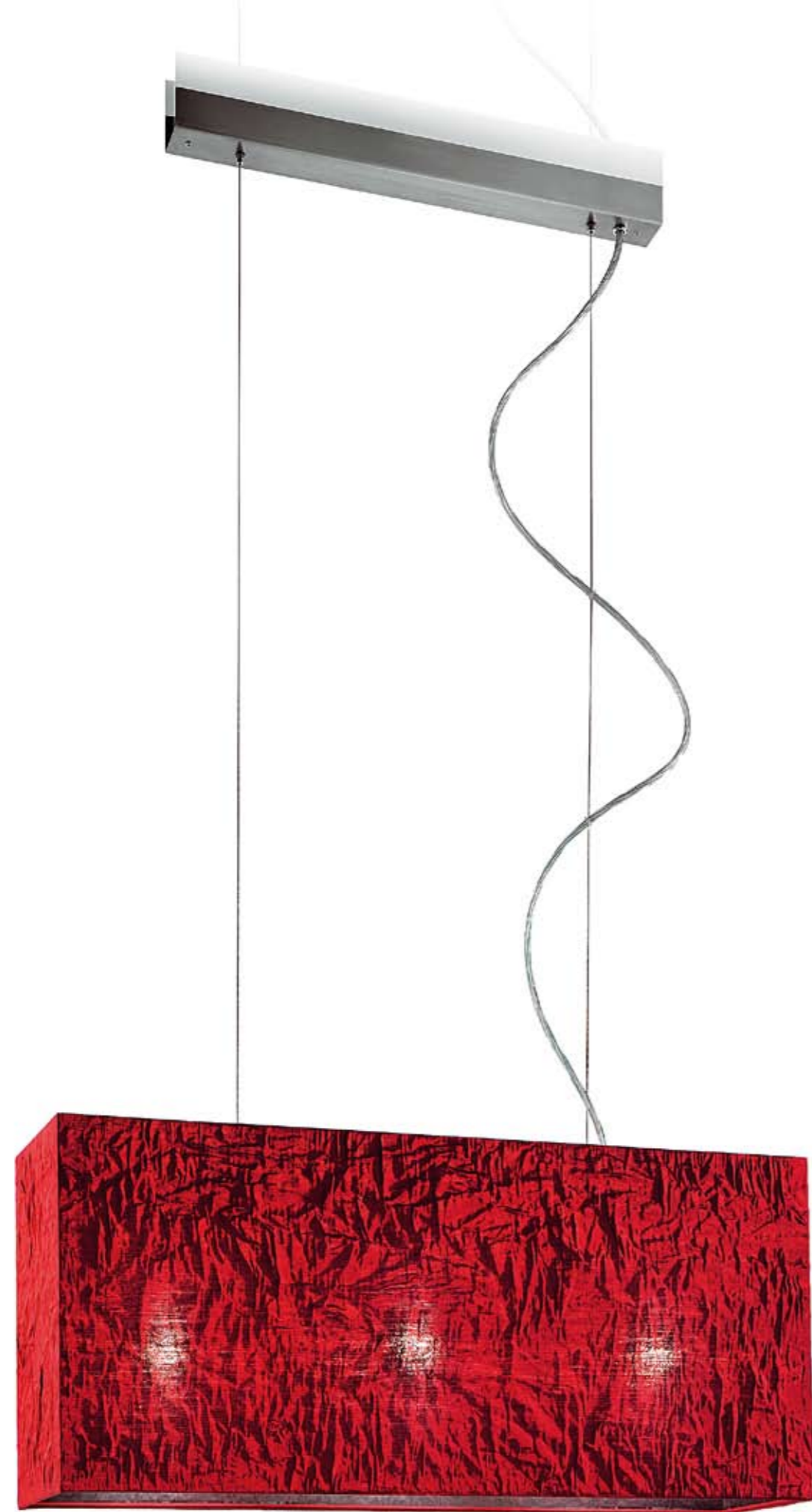

93





DRESS R/SO 60

3 x 60W E27 incand. 
 o/or
 3 x 20W E27 PL-EL.  

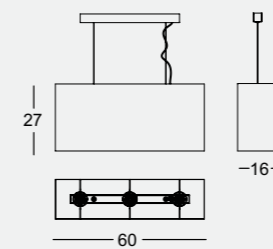
CE  IP 20



DRESS R/TA

3 x 60W E27 incand. 
 o/or
 3 x 20W E27 PL-EL.  

CE   IP 20

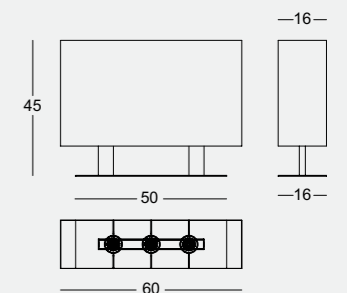

DRESS R/SO 90

4 x 60W E27 incand.

o/or

4 x 20W E27 PL-EL.

CE IP 20

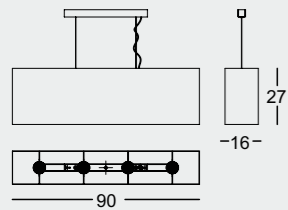

98 BROADWAY

BROADWAY
design: Andrea Lazzari

Collezione di lampade in metallo cromo satinato e oro satinato, le versioni da tavolo e terra hanno la base in vetro extrachiaro, i paralumi sono in paillettes di colore oro, argento e nero.

Collection of lamps in satin-finished metal available in the finishes chrome or gold, table lamps and floor lamps with base in extra clear glass, lampshades in paillettes in gold, silver or black colour.

Collection de lampes en métal satiné avec finitions chrome ou or, lampes à poser et lampadaires avec base en verre extra-clair, diffuseur en paillettes dans les couleurs or, argent ou noir.



Colección de lámparas en metal cromo satinado y oro satinado, los modelos de mesa y de piso tienen la base en vidrio extraclaro, las pantallas son en paillettes de color oro, plata y negro.

Serie aus satiniertem Metall in den Ausführungen chrom oder gold, Tischleuchten und Stehleuchten mit Basis aus extraklarem Glas, Lampenschirm aus Paillettes in den Farben gold, silver oder schwarz.

Коллекция ламп из металла, сатинового хромирования и сатинованной позолоты, настольные и напольные версии имеют основание из экстрасветлого стекла, абажуры из пайеток золотого, серебряного и черного цвета.





BROADWAY/TE

4 x max 60W
E27 Inc. 
o/or
4 x max 20W
E27 PL-EL  

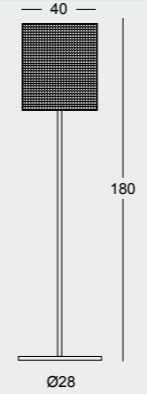





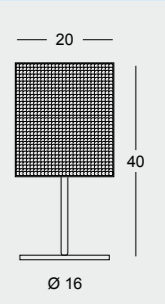

BROADWAY/CO

1 x max 100W
E27 Inc. 
o/or
1 x max 20W
E27 PL-EL  





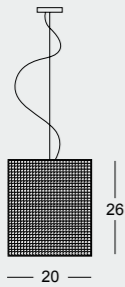

BROADWAY/SO 20

1 x max 100W
E27 Inc. 
o/or
E27 Alo. 
o/or
1 x max 23W
E27 PL-EL  



  IP 20

BROADWAY/SO 20/2

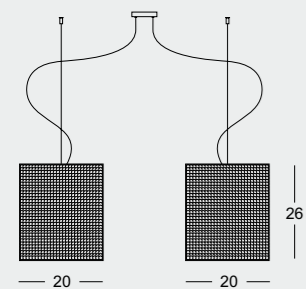

2 x max 100W
E27 Inc. 
o/or
E27 Alo. 
o/or
2 x max 23W
E27 PL-EL  

  IP 20

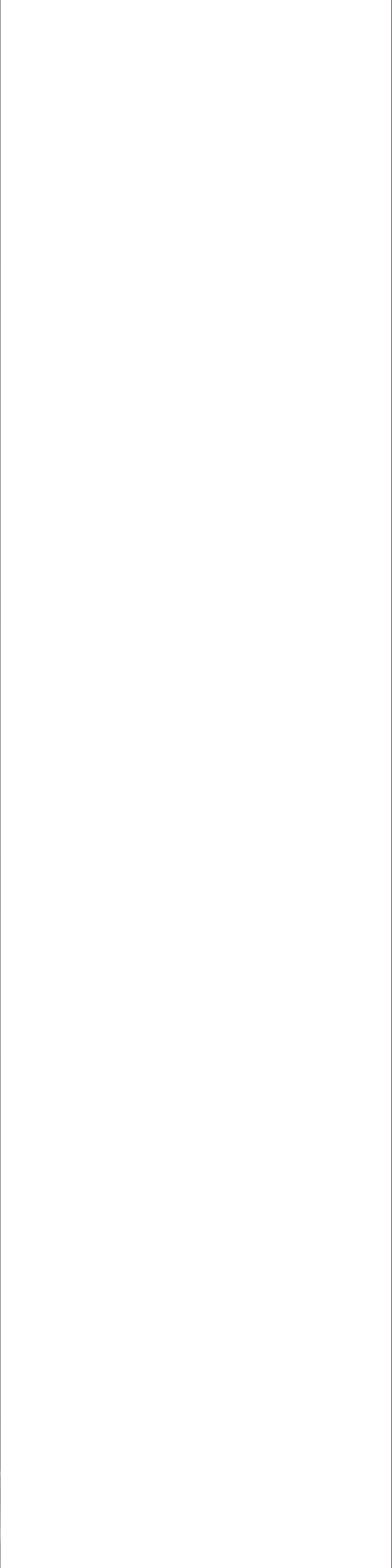



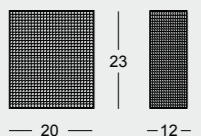

BROADWAY/PA

1 x max 100W
E27 Inc. 
o/or
1 x max 20W
E27 PL-EL  



  IP 20

BROADWAY/SO 40

4 x max 60W
E27 Inc. 
o/or
4 x max 20W
E27 PL-EL  

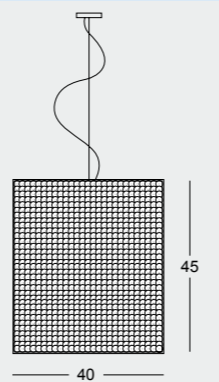

  IP 20



106 DRESS

DRESS

design: Andrea Lazzari e Massimo Tonetto

Collezione di lampade in acciaio inox satinato, diffusore in tessuto metallico, colore silver, rosso e avorio.

Collection of lamps satin finished stainless steel, metal fabric diffuser in the colours silver, red and ivory.

Collection de lampes en acier inox satiné, diffuseur en tissu métallique dans les couleurs silver, rouge et ivoire.



Colección de lámparas en acero inox satinado, difusor en tejido metálico, color silver, rojo y marfil.

Serie in Stahl Inox satiniert, Schirm Metallgewebe in den Farben silver, rot und elfenbein.

Коллекция ламп из сатирированной нержавеющей стали, отражатель из металлической ткани серебряного, красного цвета и цвета слоновой кости.



DRESS/TA

1x max
100W E27 Inc. 
o/or
1 x max 20W
E27 PL-EL 

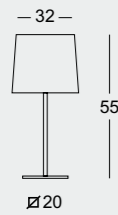





DRESS/CO

1 x max 60W
E14 Inc. 



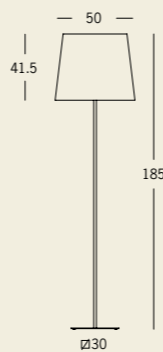

DRESS/TE

1 x max 250W
E27 Alo. 
o/or
1 x max 200W
E27 Inc. 
o/or
1 x max 23W
PL-EL. 





DRESS SO/XXL

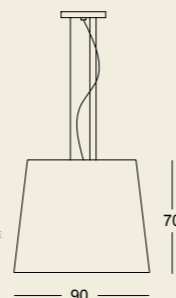

4 x max 150W
E27 Inc. 
o/or
E27 Ab. 
o/or
4 x max 23W
E27 PL-EL 

CE  IP 20





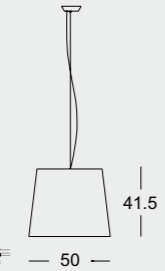

DRESS SO/C

1 x max 150W
E27 Inc. 
o/or
1 x max 150W
E27 Alo. 
o/or
1 x max 23W
E27 PL-EL 



CE  IP 20

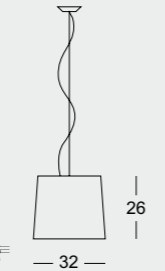

DRESS SO 32

1 x max 100W
E27 Inc. 
o/or
1 x max 100W
E27 Alo. 
o/or
1 x max 23W
E27 PL-EL 



CE  IP 20

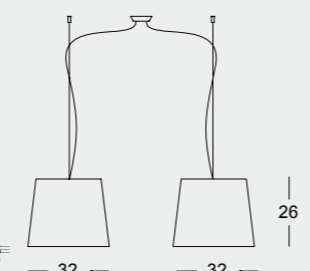

DRESS SO 32/2

2 x max 100W
E27 Inc. 
o/or
2 x max 100W
E27 Alo. 
o/or
2 x max 23W
E27 PL-EL 



CE  IP 20

DRESS/PA

1 x max 100W
E27 Inc. 
o/or
1 x max 20W
E27 PL-EL 

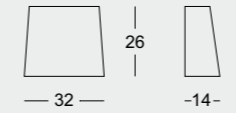

CE  IP 20 

116 FOG

FOG

design: Andrea Lazzari e Massimo Tonetto

Collezione di lampade in metallo nichel satinato, vetro soffiato bianco latte satinato, paralume in tessuto Pongé bianco, rosso e nero.
Collection of lamps in satin finished nickel metal, milk white blown glass, satin finish, lampshade in Pongé fabric white, black or red.
Collection de lampes en métal nickel satiné, verre soufflé blanc lait, finition satinée, diffuseur en tissu Pongé blanc, noir ou rouge.
Colección de lámparas en metal níquel satinado, cristal soplado blanco leche, acabado satinado, pantalla en tejido Pongé blanco, negro o rojo.
Serie aus Metall Nickel satiniert, mundgeblasenes Glas, milchweiß satiniert, Lampenschirm aus Pongé Stoffe weiß, schwarz oder rot.
Коллекция ламп из сатинированного металла-никель, выдувного сатинированного стекла молочно-белого цвета, абажур из ткани Pongé белого, красного и черного цвета.



FOG/CO

1 x max 75W
G9 Halopin

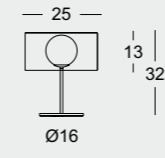

FOG/PL 50

1 x max 100W
E27 Inc.
o/or
1x max 16W
E27 Fluo.

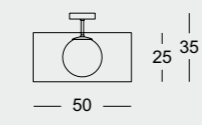

FOG/PL 70

1 x max 150W
E27 Inc.
o/or
1x max 16W
E27 Fluo.

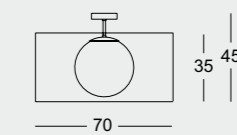



FOG/SO 35

1 x max 75W
G9 Halopin

CE IP 20

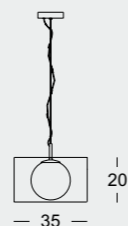

FOG/SO 35/2

2 x max 75W
G9 Halopin

CE IP 20

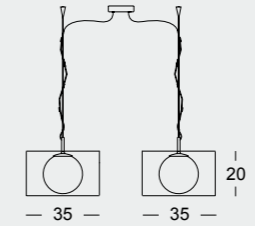

FOG/SO 50

1 x max 100W
E27 Inc.
o/or
1x max 16W
E27 Flu.

CE IP 20

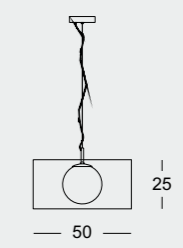

FOG/SO 70



1 x max 150W
E27 Inc.
o/or
1x max 16W
E27 Flu.

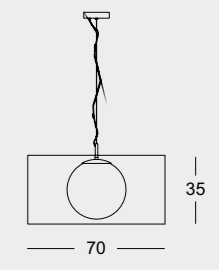

CE IP 20







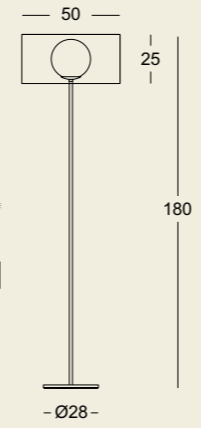

FOG/TE

1 x max 150W
E27 Inc. 
o/or
1 x max 16W
E27 Flu.  **ES**

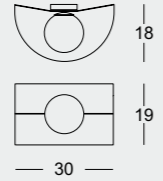

CE   **IP 20**

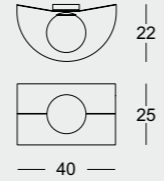



<p>FOG/PA30</p> <p>1 x max 60W G9 Halopin </p> <p>CE  IP 40</p> 	<p>FOG/PA40</p> <p>1 x max 75W G9 Halopin </p> <p>CE  IP 40</p> 
--	---



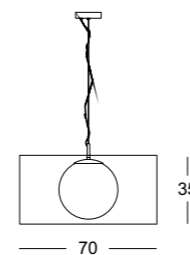

FOG/SO 70

1 x max 150W
E27 Inc. 
o/or
1x max 16W
E27 Fluo. 



CE  IP 20

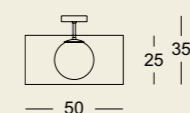

FOG/PL 50

1 x max 100W
E27 Inc. 
o/or
1x max 16W
E27 Fluo. 



CE  IP 20

FOG/PL 70

1 x max 150W
E27 Inc. 
o/or
1x max 16W
E27 Fluo. 

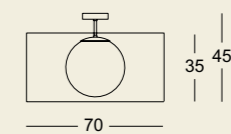

CE  IP 20

126 KUBIK

KUBIK
design: Sandi Renko

Collezione di lampade in metallo nichel satinato e parzialmente grigio alluminio, diffusore componibile con lastre di metacrilato bianco o arancione fluorescente.

Collection of lamps in metal nickel satin finish and partially aluminium grey, methacrylate unit lampshade in the colours white or fluorescent orange.

Collection de lampes en métal nickel satiné et partiellement gris aluminium, diffuseur à éléments en méthacrylate blanc or orange fluorescent.

Colección de lámparas en metal níquel satinado y parcialmente gris aluminio, difusor componible con hojas de metacrilato blanco o aranjado fluorescente.

Serie aus Metall Nickel satiniert und teilweise aluminium-grau, Lampenschirm mit Bestandteilen aus Methacrylat weiß oder orange fluoreszierend.

Коллекция ламп из серого металла-алюминия, отражатель комплектуется пластинами из метакрилата белого или опалового красного цвета.



KUBIK/PL 70

7 x max 60W
G9 Halopin

CE F IP 20

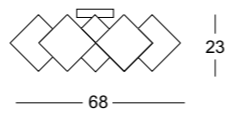

KUBIK/SO 70

7 x max 60W
G9 Halopin

CE F IP 20

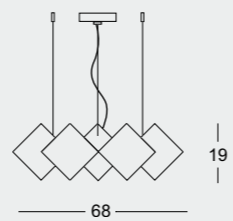

130 BUTTERFLY

BUTTERFLY
design: Andrea Lazzari

Collezione di sospensioni in metallo, verniciatura antigraffio nelle colorazioni; Arancio Sun, Bianco Moon e Nero Crow.
Collection of suspensions in metal, with anti-scratch lacquering in the colours Sun orange, Moon white and Crow black.
Collection de suspensions en métal, vernis anti-égratignure dans les couleurs Sun orange, Moon blanc et Crow noir.
Colección de suspensiones en metal, barniz irrayable en colores Anaranjado Sun, Blanco Moon y Negro Crow.
Serie von Hängelampen aus Metall, mit anti-kratzen Lackierung in den Farben Sun orange, Moon weiß und Crow schwarz.
Коллекция подвесок из металла, нецарапываемая окраска в цветах: Оранжевый Солнечный, Белый Лунный и Черный Вороной.

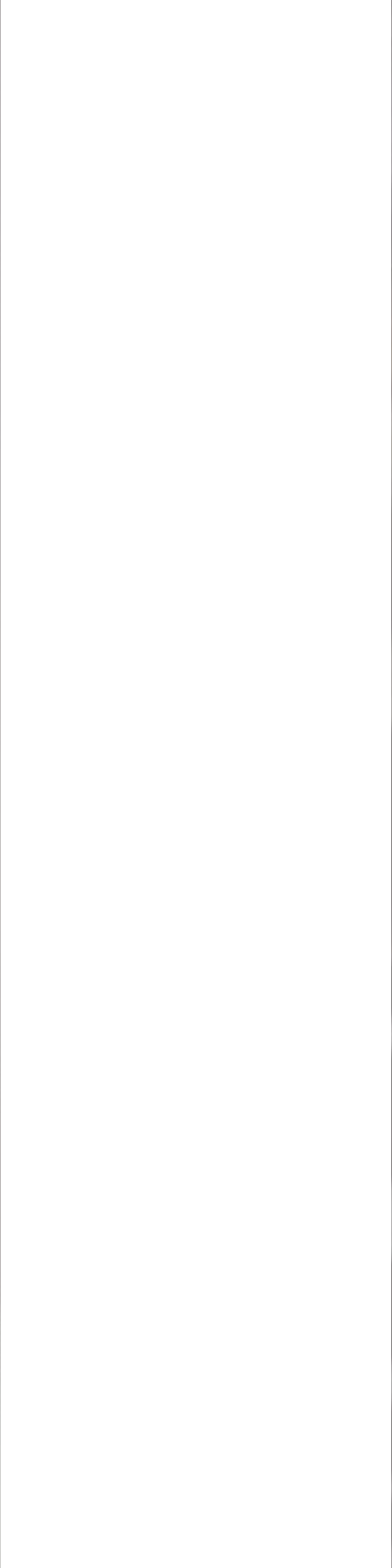

BUTTERFLY

- 1 x max 150W
E27 inc.
- o/or
- 1 x max 21W
E27 PL-EL

CE F IP20

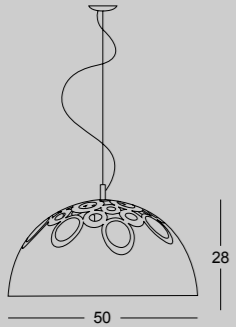

134 SATURNO

SATURNO

design: Andrea Lazzari e Massimo Tonetto

Collezione di lampade in grigio alluminio, diffusore in metacrilato trasparente o fluorescente arancione, giallo e blu.

Collection of lamps in aluminium grey, methacrylate diffuser transparent or fluorescent orange, yellow and blue.

Collection de lampes en gris aluminium, diffuseur en méthacrylate transparent ou fluorescent orange, jaune et bleu.

Colección de lámparas gris aluminio, difusor en metacrilato transparente o fluorescente aranjado, amarillo y azul.

Serie in Aluminium grau, Schirm aus Methacrylat transparent oder mit Fluoreszierend orange, gelb und blau.

Коллекция ламп из серого металла-алюминия, отражатель из прозрачного или флюоресцентного метакрилата оранжевого, желтого и синего цвета.

SATURNO/SO
1 x max 22W 2GX13



CE IP 20

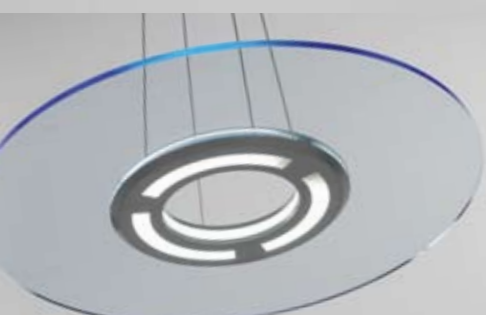
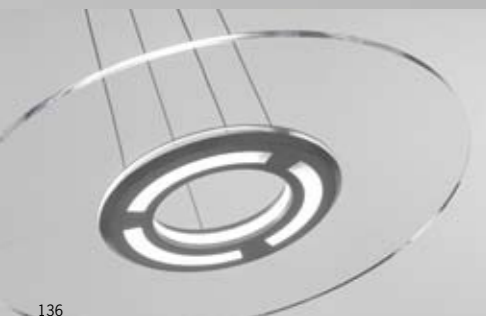
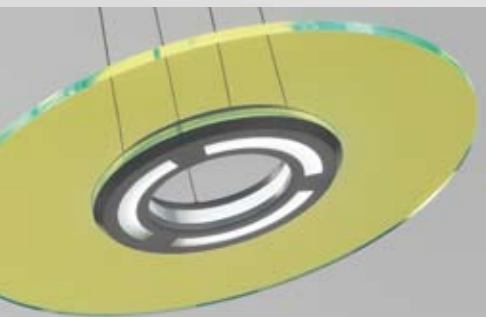
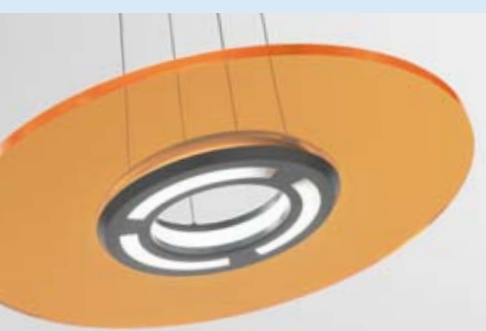
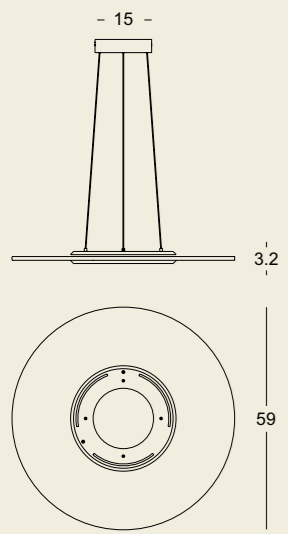

138 YOUNG

YOUNG

design: Andrea Lazzari e Massimo Tonetto

YOUNG/TE

1 x max 150W

E27 Inc. 

o/or

1 x max 150W

E27 Alo. 

o/or

1 x max 23W

E27 PL-EL. 

   IP 20

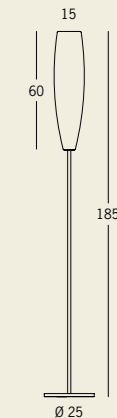

Collezione di lampade in metallo cromato, diffusore in vetro soffiato bianco latte satinato e solo per versione MINI YOUNG in Bone China bianco con finitura lucida.
Collection of lamps in chrome-metal, diffuser in satinéd milk white blown glass and only for the versions MINI YOUNG in white Bone China, polished finish.
Collection de lampes en métal chromé, diffuseur en verre soufflé blanc lait satiné et seulement pour les versions MINI YOUNG en Bone China blanc, finition brillante.
Colección de lámparas en metal cromado, difusor en cristal soplado blanco leche satinado y solo para la versión MINI YOUNG en Bone China blanco con acabado lucido.
Serie aus Metall Chrom, Schirm aus Mund-geblasenem Glas milch weiss satiniert und nur für die Version MINI YOUNG aus Bone China, weiß glänzend.
Коллекция ламп из хромированного металла, отражатель из выдувного стекла сатинового матово-белого цвета и только для версии MINI YOUNG из белого Bone China с блестящей отделкой.



YOUNG/SO MINI

1 x max 75W
G9 Halopin



CE IP 20

System 100 A

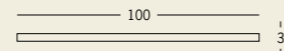

System 150 A

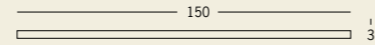

CE IP 20



YOUNG/SO

1 x max 100W
E27 Inc. o/or
1 x max 100W
E27 Alo. o/or
1 x max 23W
E27 PL-EL.



CE IP 20

YOUNG/SO 1 MINI

1 x max 75W
G9 Halopin



CE IP 20

YOUNG/SO 2 MINI

2 x max 75W
G9 Halopin

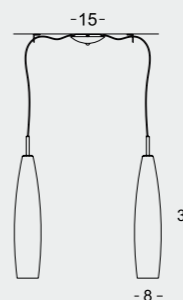

CE IP 20

YOUNG/SO 3 MINI

3 x max 75W
G9 Halopin

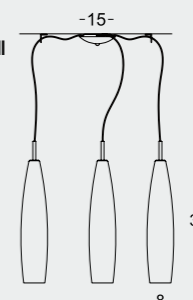

CE IP 20

YOUNG/SO 4 MINI

4 x max 75W
G9 Halopin

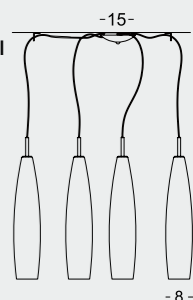

CE IP 20

142 SPACE

SPACE

design: Andrea Lazzari e Massimo Tonetto

Collezione di lampade in metallo cromato, diffusore in Bone China bianco con finitura lucida.

Collection of lamps in chrome-metal, diffuser in white Bone China, polished finish.

Collection de lampes en métal chromé, diffuseur en Bone China blanc, finition brillante.

Colección de lámparas en metal cromado, difusor en Bone China blanco, acabado lucido.

Serie in Chrom, Schirm aus Bone China, weiß glänzend.

Коллекция ламп из хромированного металла, отражатель из Bone China белого цвета с блестящей отделкой.



SPACE/LA 120

24 x max 10W
G4 Halostar 

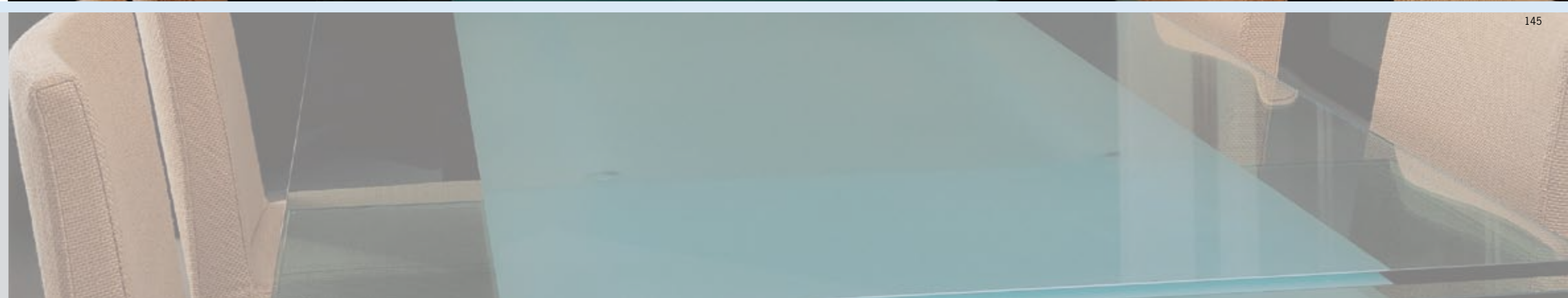
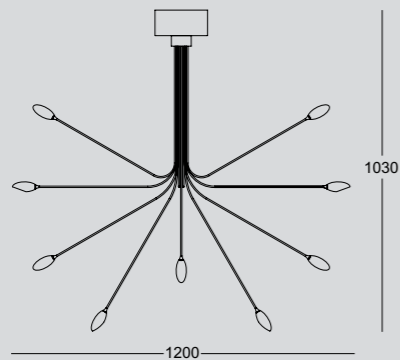

146 EGG

EGG
design: Ufficio Tecnico



146

Collezione di lampade in metallo cromato, diffusore in Bone China bianco con finitura lucida o in vetro soffiato bianco latte satinato.
Collection of lamps in chrome-metal, diffuser in white Bone China, polished finish or in satined milk white blown glass
Collection de lampes en métal chromé, diffuseur en Bone China blanc, finition brillante ou en verre soufflé blanc lait satiné.
Colección de lámparas en metal cromado, difusor en Bone China blanco, con acabado lucido o en cristal soplado blanco leche satinado.
Serie in Chrom, Schirm aus Bone China, weiß glänzend oder aus mundgeblasenem Glas milchweiss satiniert.
Коллекция ламп из хромированного металла, отражатель из белого Bone China с блестящей отделкой или из выдувного стекла сатинированного молочно-белого цвета.

147

EGG/PA

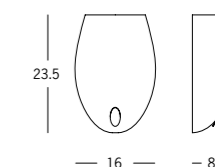

2 x max 40W
E14 Inc.



— 16 — — 8 —





EGG/S01

1 x max 100W
E27 Inc. 
o/or
1 x max 20W
PL-EL.  

CE   





EGG/S02

2 x max 100W
E27 Inc. 
o/or
2 x max 20W
PL-EL.  

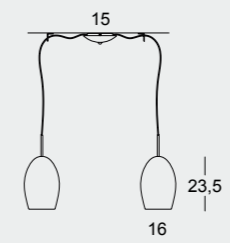
CE   





EGG/S03

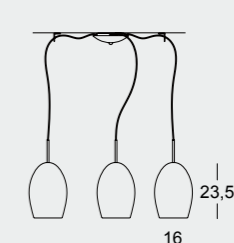

3 x max 100W
E27 Inc. 
o/or
3 x max 20W
PL-EL.  

CE   



EGG/S04

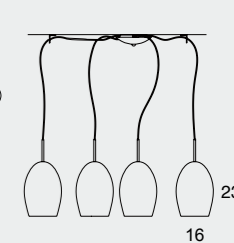

4 x max 100W
E27 Inc. 
o/or
4 x max 20W
PL-EL.  

CE   





EGG/SO

1 x max 100W
E27 Inc. 
o/or
1 x max 20W
PL-EL.  

CE  IP20

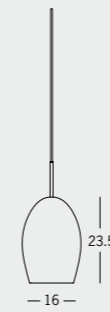

System 100 A

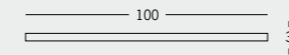



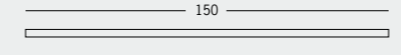

System 150 A



CE  IP20

EGG/TE

1 x max 100W
E27 Alo. 
o/or
1 x max 100W
E27 Inc. 
o/or
1 x max 20W
E27 PL-EL.  

CE   IP20

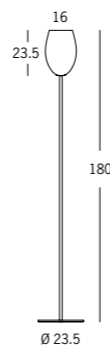

EYE GLASS
design: Andrea Lazzari

15
EYE GLASS



Lampada da parete in metallo verniciato grigio alluminio, diffusori in vetro soffiato disponibili nelle colorazioni; bianco latte satinato, nero satinato, rosso satinato.
Wall lamp in aluminium grey varnished metal, diffusers in blown glass available in the colours: satinéd milk white, satinéd black, satinéd red.
Lampe à mur en métal verni en gris aluminium, diffuseurs en verre soufflé available dans les couleurs: blanc lait satiné, noir satiné, rouge satiné.
Wandleuchte aus Metall Aluminiumgrau lackiert, Diffusoren aus Mund geblasenem Glas verfügbar in den Farben: milch weiss satiniert, Schwarz satiniert, rot satiniert.
Aplique en metal pintado gris aluminio, difusores en cristal soplado disponibles en los colores: blanco leche satinado, negro satinado, rojo satinado.
Настенная лампа из покрашенного металла серо-алюминиевого цвета, отражатели из выдувного стекла доступны в цветах: сатинированный молочно-белый, сатинированный чёрный, сатинированный красный.

EYE CO glass

1x max 60W E14 incand.

CE IP20



EYE PP glass

1x max 60W E14 incand.

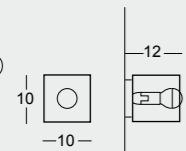

CE IP 20

EYE PP glass

1x max 60W E14 incand.

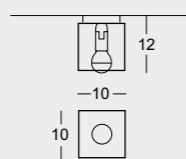

CE IP 20

156 EYE



EYE

design: Andrea Lazzari

Lampada da parete in alluminio anodizzato, nei colori alluminio, nero, oro.
Wall bracket lamp in anodized aluminium, in the colours aluminium, black and gold.
Applique en aluminium anodisé, dans les couleurs aluminium, noir et or.
Applique en aluminio anodizado, color aluminio, negro y oro.
Wandleuchter in rein Aluminium eloxiert, in den Farben aluminium, schwarz und gold.
Настенная лампа из анодированного алюминия, алюминиевого цвета, чёрного цвета и золотого цвета.



EYE/PA

1x max 40W E14 incand.
lampadina inclusa
bulb included

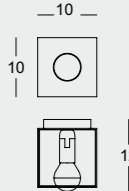

160 DUNE

DUNE
design: Sandi Renko

Collezione di lampade in metallo verniciato bianco opaco, diffusore in vetro extrachiaro, serigrafato parzialmente bianco e poi sabbiato.
Collection of lamps in matt white varnished metal, shades in extra light glass, partially white screen-printed and then sanded.
Collection de lampes en metal verni en blanc opaque, abat-jour en verre extra Claire, partiellement serigraphié blanc et après sable.
Kollektion von leuchten aus Metall nickel satiniert, Schirm aus extra klarem Glas, teilweise weiss siebgedruckt und dann sand-gestrahlt.
Colección de lámparas en metal pintado blanco opaco, difusor en cristal extraclaro, serigrafado parcialmente blanco y después arenado.
Коллекция ламп из покрашенного металла матово-белого цвета, отражатель из экстра-светлого стекла, на часть сериграфированное белым цветом и потом обработанное пескоструйкой.



DUNE/PP 60 E

2 x max 24W
G5 Fluo.

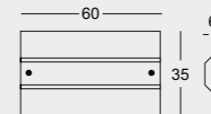

E-ballast elettronico/electronic ballast

DUNE/PL 90 E

2 x max 39W
G5 Fluo.

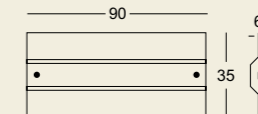

E-ballast elettronico/electronic ballast



DUNE/SO 90 E

2 x max 39W
G5 Fluo.

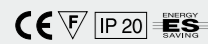
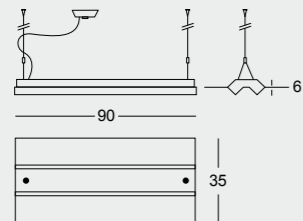

E-ballast elettronico/electronic ballast
dimmerabile / dimmable / dimmbar
Возможность регулировки интенсивности света

DUNE/SO 120 E

2 x max 54W
G5 Fluo.

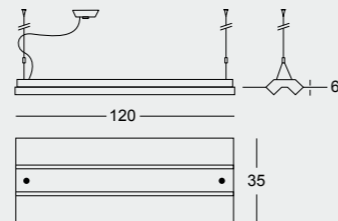

E-ballast elettronico/electronic ballast
dimmerabile / dimmable / dimmbar
Возможность регулировки интенсивности света

166 NEMESI

NEMESI

design: Andrea Lazzari e Massimo Tonetto

Collezione di lampade in alluminio anodizzato, vetro extrachiaro serigrafato bianco, giallo, arancione e verde mela con finitura satinata.

Collection of lamps in anodized aluminium metal, extra clear glass with screen printing in white, yellow, orange and apple green, satin finish.

Collection de lampes en aluminium anodisé, verre extra-clair sérigraphié en blanc, jaune, orange et vert pomme, finition satinée.

Colección de lámparas en aluminio anodizado, cristal extraclaro serigrafado blanco, amarillo, aranjado o verde manzana, acabado satinado.

Serie aus eloxiertem Aluminium, Glas extraklar mit Siebdruck weiß, gelb, orange oder apfelgrün, satiniert.

Коллекция ламп из анодированного алюминия, экстрасветлое серигрифированное стекло белого, желтого, оранжевого и яблочно-зеленого цвета с сатирированной отделкой.



NEMESI 23/PA

1 x max 150W
R7s 114,2 mm.

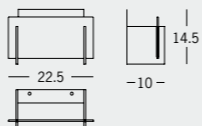

NEMESI 40/PA

2 x max 150W
R7s 114,2 mm.

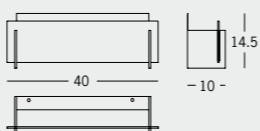

NEMESI 40/PA M-E

1 x max 24W
2G11 Fluo.

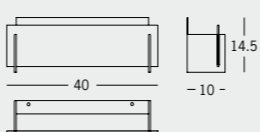
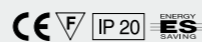

M - ballast elettromagnetico/electromecanical ballast
E - ballast elettronico/electronic ballast

NEMESI 63/PA

2 x max 150W
R7s 114,2 mm.



NEMESI 63/PA E

1 x max 55W
2G11 Fluo.

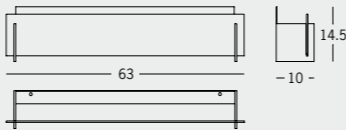

M - ballast elettromagnetico/electromecanical ballast
E - ballast elettronico/electronic ballast





NEMESI/PP

4 x max 60W
E14 Incand. 



NEMESI/PP E

2 x max 24W
2G11 Fluo. 
E - ballast elettronico/electronic ballast

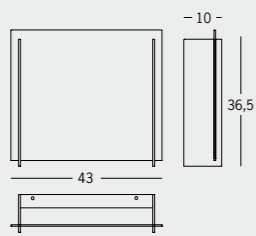

KIT NEMESI/PP - PPE

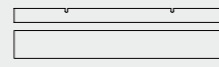

Opzionale: 2 schermi protezione in policarbonato
Optional: 2 protective polycarbonate screens
Optional: 2 Lichtschutzen aus Polycarbonat
Optional: 2 écrans de protection en polycarbonate
Opcional: 2 pantallas de proteccion en policarbonato
Дополнительно: 2 защитных экрана из поликарбоната





NEMESI/SO

2 x max 54W
G5 fluo.

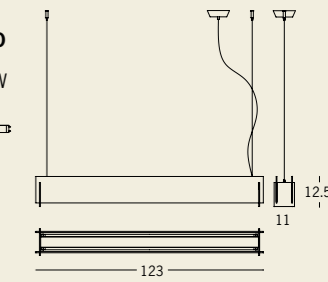
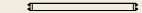

E-ballast elettronico/electronic ballast

dimmerabile / dimmable / dimmbar
Возможность регулировки интенсивности света



NEMESI 123/PA E

1 x max 54W
G5 fluo.

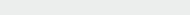

E-ballast elettronico/electronic ballast

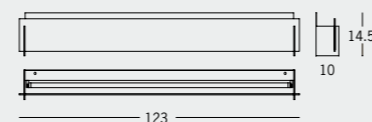

174 SUNRISE

SUNRISE
design: Ufficio Stile

SUNRISE: Lampade da parete in acciaio nelle finiture; inox satinato, bianco e nero, disponibile in versione con lenti ottiche trasparenti.

Wall bracket lamps made of steel in the finishes satin stainless steel, white and black, available with transparent optical lenses.

Appliques en acier avec finitions acier inox satiné, blanc et noir, disponible avec lentilles optiques transparentes.

Apliques acabado en acero, acero inox satinado, blanco y negro, disponible con lentes opticas transparentes.

Wandleuchten aus Stahl in den Ausführungen Stahl Inox satiniert, weiß und schwarz, erhältlich auch mit optischer transparenten Linse.

Настенные лампы из стали в отделке; сатинированная нержавеющая сталь белого и черного цвета предоставляется в версии с прозрачными оптическими линзами.

SUNRISE 120 - 260 - 380 - 500: Lampade da parete in acciaio nelle finiture; inox satinato, bianco e nero, disponibile in versione con vetro extrachiaro satinato.

Wall bracket lamps made of steel in the finishes satin stainless steel, white and black, available with extra clear satin glass.

Applique en acier avec finitions acier inox satiné, blanc et noir, disponible avec verre extra-clair satiné.

Apliques acabado en acero, acero inox satinado, blanco y negro, disponible con cristal extraclaro satinado.

Wandleuchten aus Stahl in den Ausführungen Stahl Inox satiniert, weiß und schwarz, erhältlich auch mit extraklarem satinierten Glas.

Настенные лампы из стали в отделке; сатинированная нержавеющая сталь белого и черного цвета предоставляется в версии с экстрасветлым сатинированным стеклом.

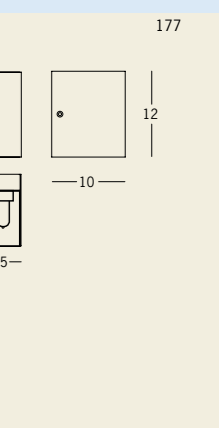
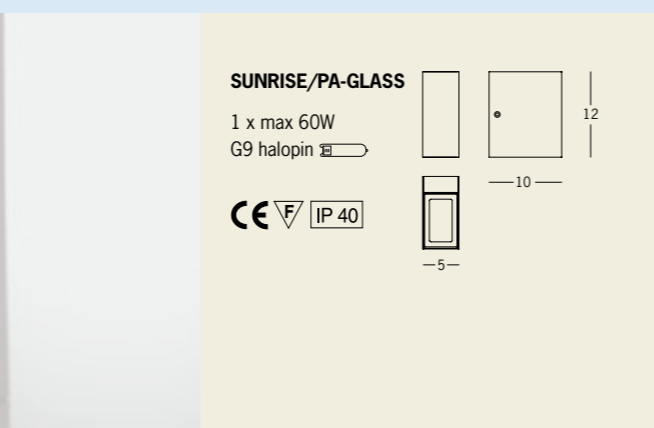
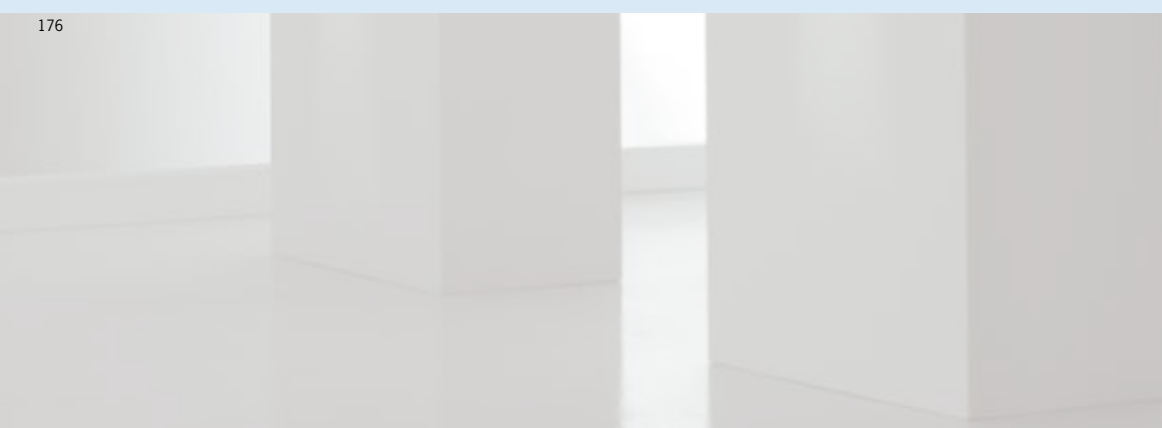

SUNRISE/PA-GLASS

1 x max 60W
G9 halopin

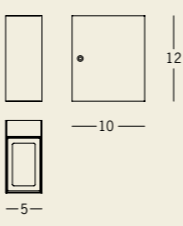

SUNRISE/PA

1 x max 75W
G9 halopin

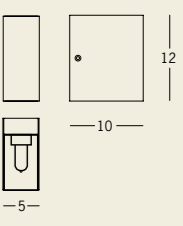



SUNRISE/260 PA

1 x max 150W
R7s 114,2 mm 



SUNRISE/260 PA E

1 x max 18W
2G11 Fluo. 



E - ballast elettronico/electronic ballast

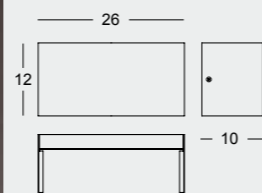

SUNRISE/380 PA

2 x max 100W
R7s 74,9 mm 



SUNRISE/380 PA E

1 x max 24W
2G11 Fluo. 



E - ballast elettronico/electronic ballast

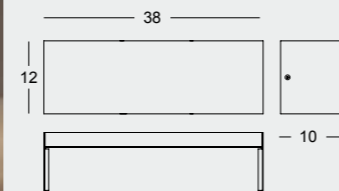

SUNRISE/500 PA

2 x max 150W
R7s 114,2 mm 



SUNRISE/500 PA E

1 x max 36W
2G11 Fluo. 

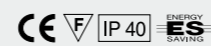

E - ballast elettronico/electronic ballast

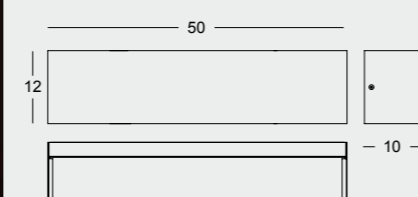



SUNRISE 120/PA GLASS

1 x max 75W
G9 halopin

CE IP 40

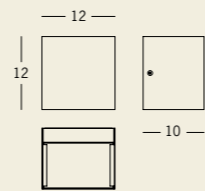

SUNRISE 120/PA

1 x max 75W
G9 halopin

CE IP 20

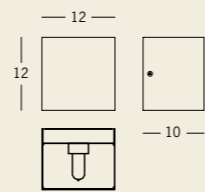

182 ZEUS

ZEUS

design: Andrea Lazzari e Massimo Tonetto

Lampade da parete in acciaio inox satinato, vetro extrachiaro curvato serigrafato bianco con finitura satinata.

Wall bracket satin finished stainless steel, extra clear bent glass with white screen printing, satin finish.

Appliques en acier inox satiné, verre extra-clair courbe sérigraphié blanc, finition satinée.

Appliques en acero inox satinado, cristal extraclaro curvado serigrafado blanco, acabado satinado.

Wandleuchter aus Stahl Inox satiniert, Glas extraklar gebogen mit Siebdruck, weiß satiniert.

Настенные лампы из нержавеющей сатинированной стали, экстрасветлое стекло, изогнутое, белая сериграфия с сатинированной отделкой.



ZEUS 28/PA

1 x max 100W
R7s 74,9 mm. 

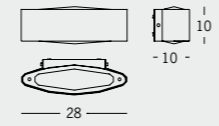

ZEUS 35/PA

1 x max 150W
R7s 114,2 mm. 

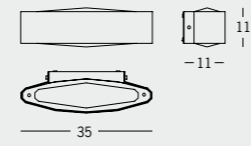

ZEUS 45/PA

2 x max 100W
R7s 74,9 mm. 

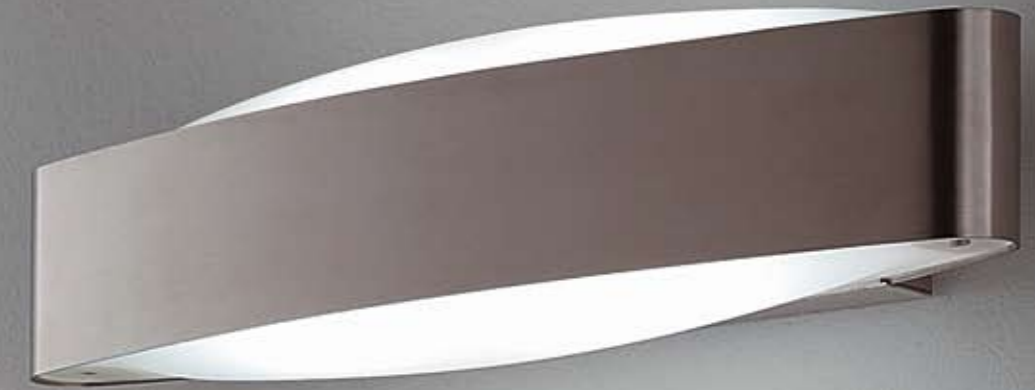
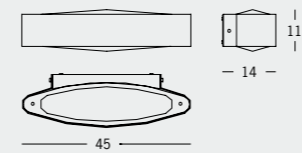

186 ARES

ARES

design: Andrea Lazzari e Massimo Tonetto

Collezione di lampade in metallo nichel satinato, vetro extrachiaro parzialmente serigrafato.

Collection of lamps in satin-finished nickel, extra clear glass partially screen printed.

Collection de lampes en métal nickel satiné, verre extra-clair partiellement sérigraphié.

Colección de lámparas en metal níquel satinado, cristal extraclaro parcialmente serigrafado.

Serie aus nickel satiniert, Glas extraklar teilweise mit Siebdruck.

Коллекция ламп из сатинированного никелированного металла, экстрасветлое стекло, частично сериграфированное.



ARES/PL-SV

1 x max 75W
E27 par30

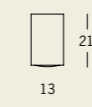

CE IP 20

ARES/PL

1 x max 75W
E27 par30

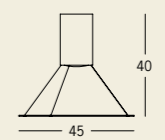

CE IP 20

190 BIBLOS

BIBLOS

design: Andrea Lazzari e Massimo Tonetto



Lampada da parete in alluminio anodizzato.

Wall bracket lamp in anodized aluminium.

Applique en aluminium anodisé.

Aplicue en aluminio anodizado.

Wandleuchter in rein Aluminium eloxiert.

Настенная лампа из анодированного алюминия.



BIBLOS/PA

1 x max 150W

R7s 74,9 mm.

CE  IP 20

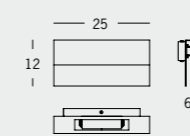

192 FUNZIONE

FUNZIONE
design: It Lab

Lampada da parete in acciaio inox satinato.
Wall bracket, satin finished stainless steel.
Applique en acier inox satiné.
Applique en acero inox satinado.
Wandleuchter aus Stahl Inox satiniert.
Настенная лампа из сатинированной нержавеющей стали.



FUNZIONE/PA

1 x max 150W
R7s 74,9 mm.

CE V F IP20

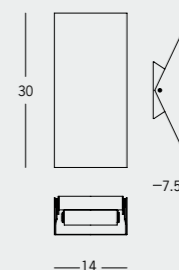

SPRING
pag.04

DICE
pag.10

FLORIAN
pag.14

FLAT Q-R-PP
pag.20

QUADRI
pag.30

AZIMUT
pag.36

MILLERIGHE
pag.42

GIGLIO
pag.46

ROUND
pag.52

ALASKA/SNOW
pag.60-61

COOL
pag.64

ASIA
pag.72

WAVE
pag.80

CLUB
pag.84

DRESS R
pag.88

BROADWAY
pag.98

DRESS
pag.106

LAMPADA DA PARETE
WALL BRACKET

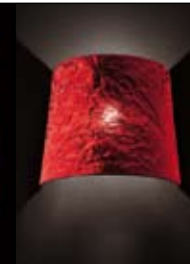

LAMPADA DA PLAFONE
CEILING LAMP

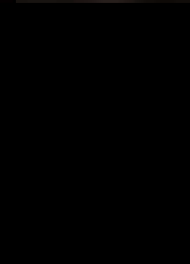
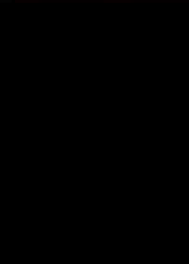
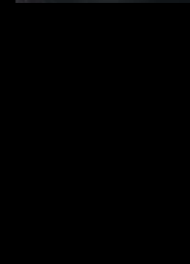
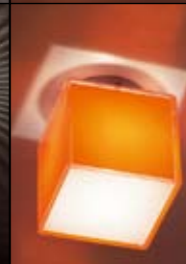

LAMPADA DA SOSPENSIONE
SUSPENSION

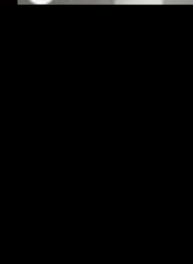
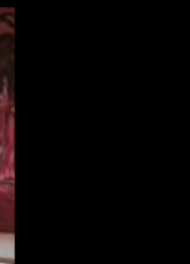
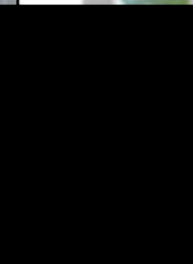
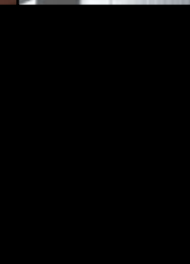

LAMPADA DA TERRA
FLOOR LAMP

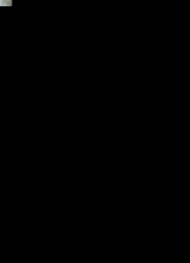
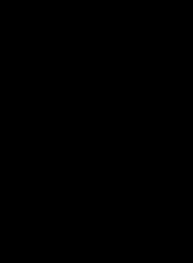
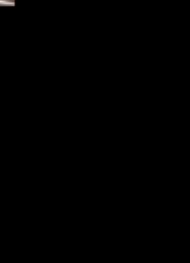
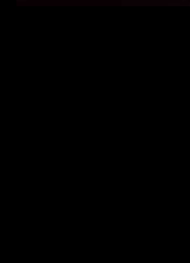
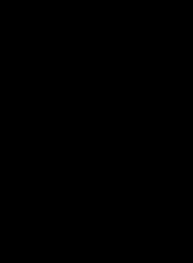
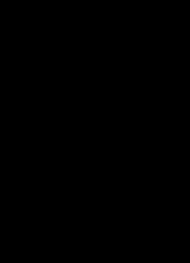
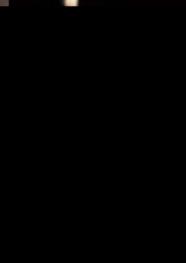

LAMPADA DA TAVOLO/COMODINO
TABLE LAMP/
NIGHT TABLE LAMP

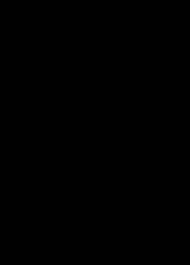
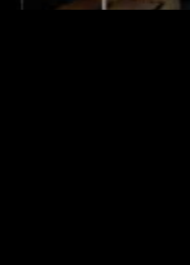
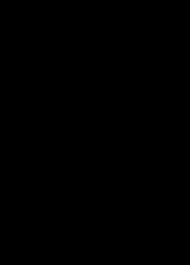

LAMPADA DA PARETE/TERRA
WALL BRACKET/
FLOOR LAMP

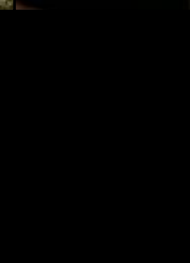
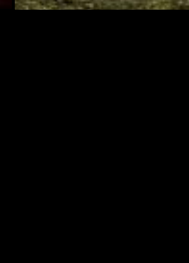
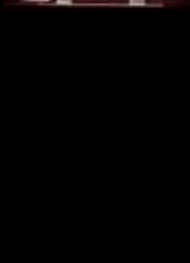
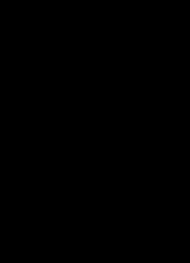
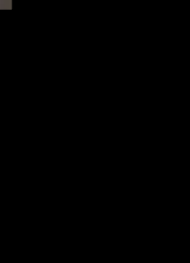
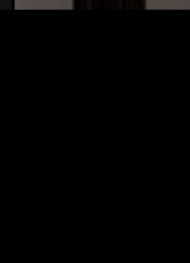
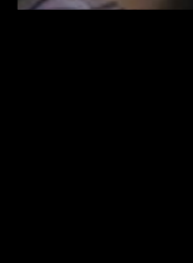
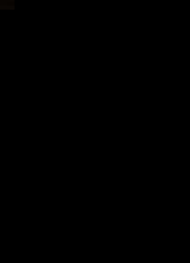
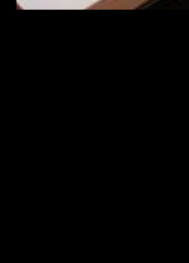
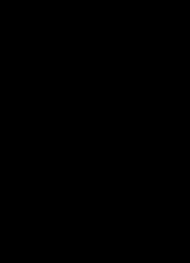
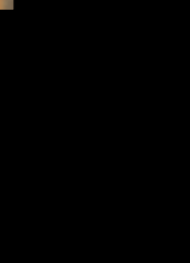
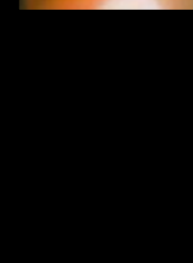
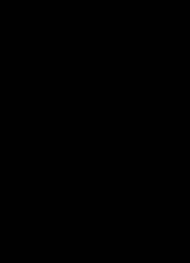
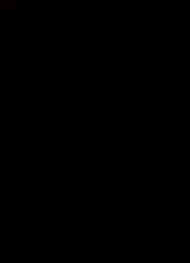
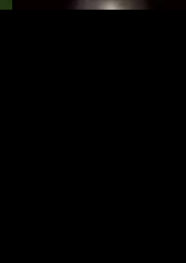
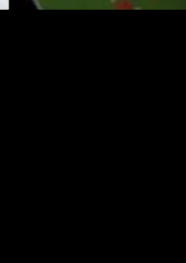

LAMPADA DA INCASSO
RECESSED SPOT

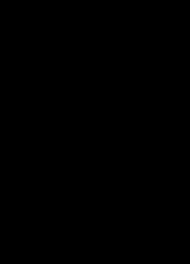
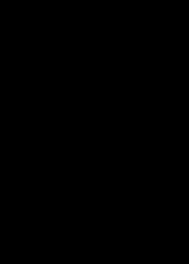
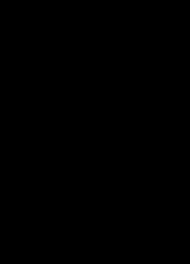
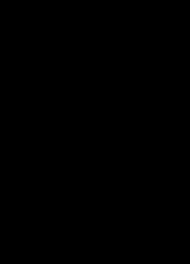
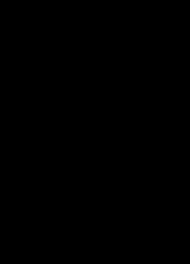
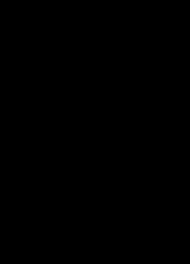
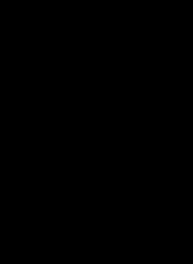
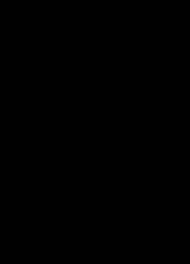
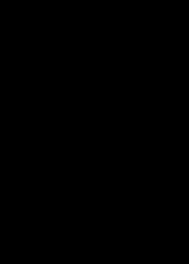
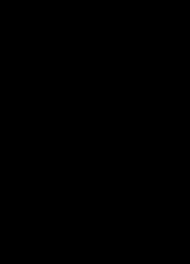
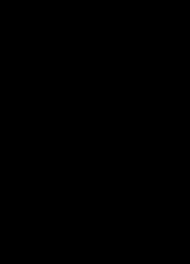
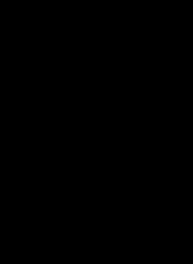
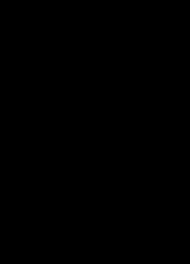
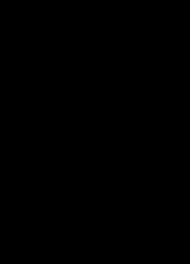
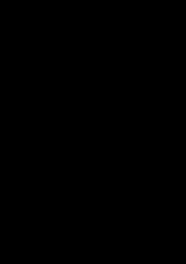
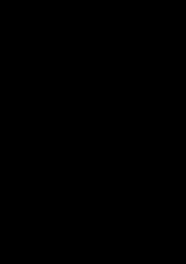

FOG
pag.116

KUBIK
pag.126

BUTTERFLY
pag.130

SATURNO
pag.134

YOUNG
pag.138

SPACE
pag.142

EGG
pag.146

EYE GLASS
pag.152

EYE
pag.156

DUNE
pag.160

NEMESI
pag.166

SUNRISE
pag.174

ZEUS
pag.182

ARES
pag.186

BIBLOS
pag.190

FUNZIONE
pag.192

LAMPADA DA
PARETE
WALL BRACKET

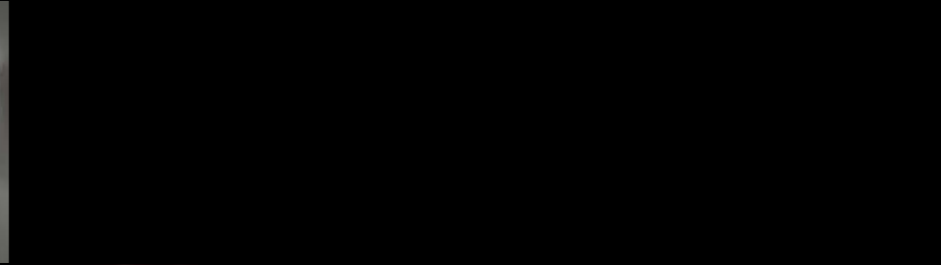

LAMPADA DA
PLAFONE
CEILING LAMP

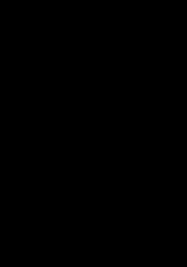
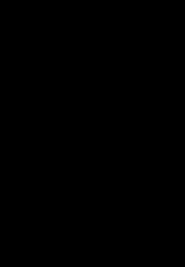
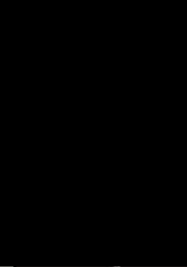

LAMPADA DA
SOSPENSIONE
SUSPENSION

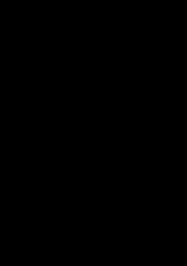
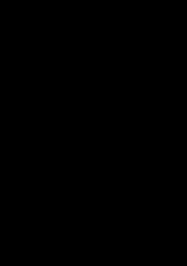
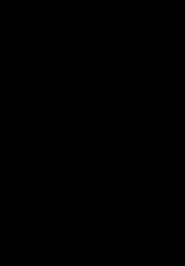
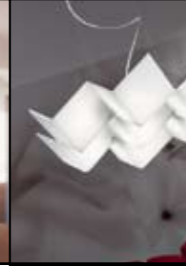

LAMPADA DA
TERRA
FLOOR LAMP

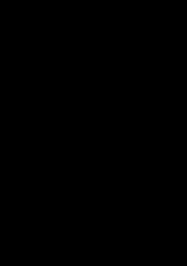
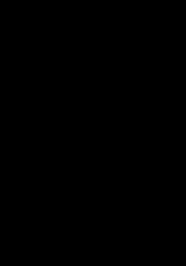
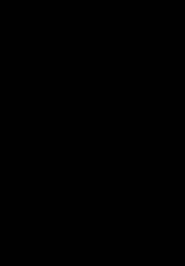
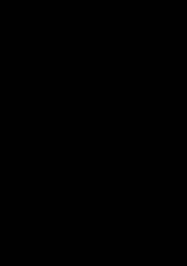
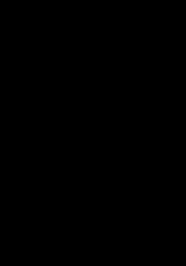
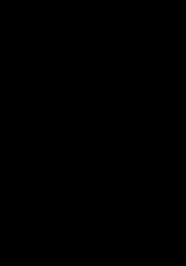
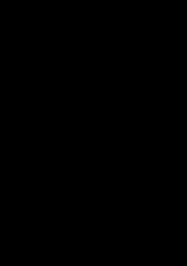
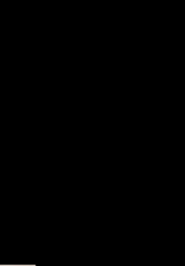
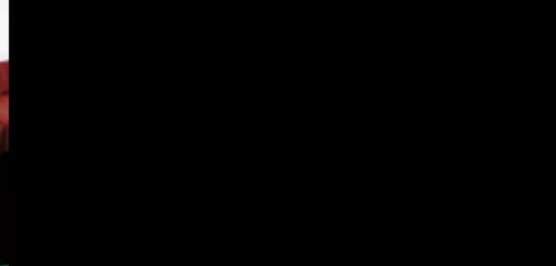

LAMPADA DA
TAVOLO/
COMODINO
TABLE LAMP/
NIGHT TABLE
LAMP

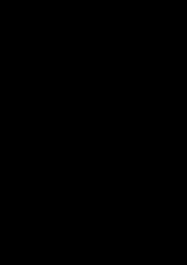
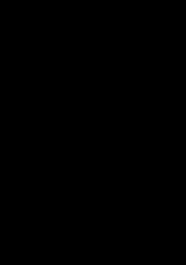
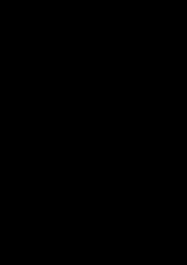
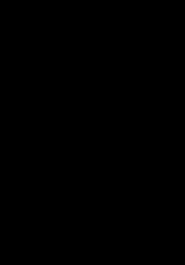
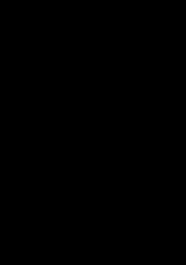
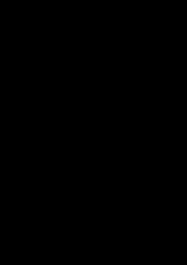
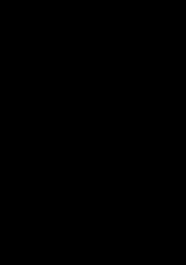
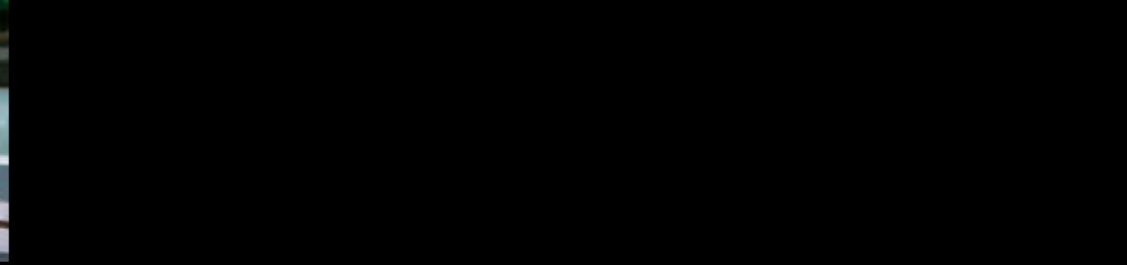



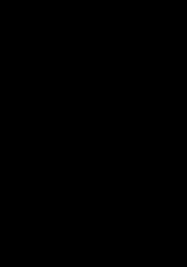
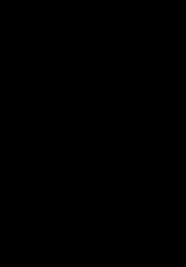
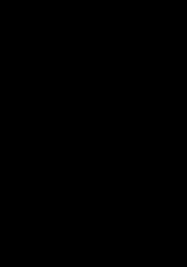
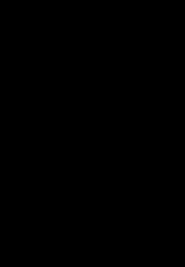
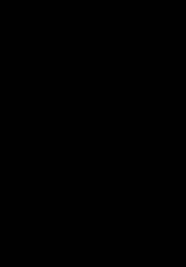
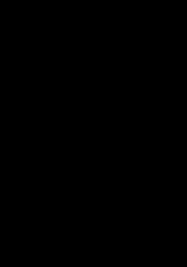
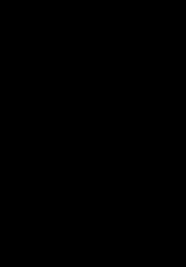
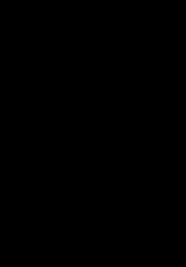
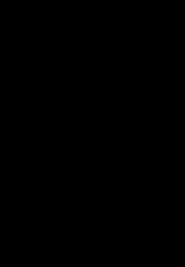
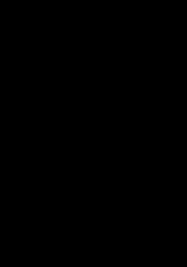
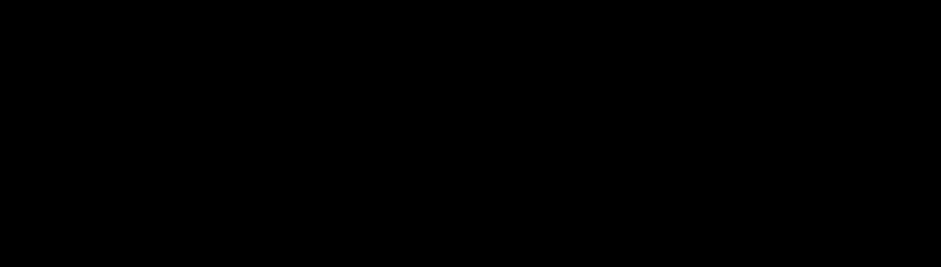



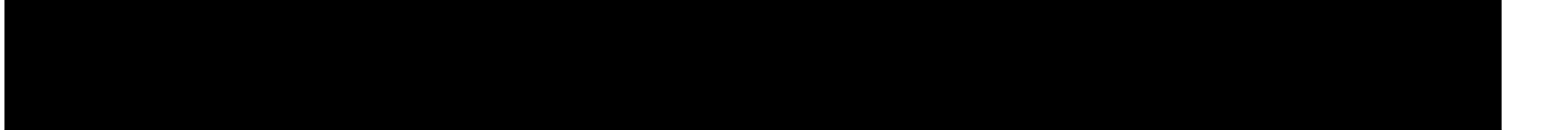







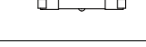



LAMPADA DA
PARETE/TERRA
WALL BRACKET/
FLOOR LAMP



LAMPADA DA
INCASSO
RECESSED SPOT



Lampadine

	Tipo di lampadina <i>Light source</i>	Tipo di attacco <i>Base</i>	Finitura <i>Type</i>	Volts <i>Voltage</i>
Lampadine ad incandescenza				
	A60 goccia	E 27	Opalina	230
	A60 sferetta	E 27	Chiara	230
	D45 sferetta	E 14	Chiara	230
	D45 oliva	E 14	Opalina	230
Lampadine ad alogeni				
	QT-DE	R7s 114.2	Chiara	230
	QT-DE 12	R7s 74.9	Chiara	230
	Doppio involucro	E 27	Smerigliata	230
	Doppio involucro	E14	Smerigliata	230
	PAR 30	E 27	Chiara	230
	G 120 globe	E 27	Opalino	230
	PAR-16	GU 10	Riflettore in alluminio	230
	QT-9	G4	Chiara	230
	Halopin	G9	Smerigliata	230
Lampadine a fluorescenza				
	PL	E 27	Bianco latte	230
	T5-FQ	G5	Bianco latte	230
	T5	2GX13	Bianco latte	230
	PL	E 27	Bianco latte	230
	PL	E 14	Bianco latte	230
	TC-L	2G11	Bianco latte	230

Legenda



Tutte le lampade sono costruite secondo le norme europee EN 60598-1 e con materiali approvati da vari istituti di sicurezza.
All the lamps are made according to European standards EN 60598-1 and of materials approved by various safety institutes.



Apparecchio predisposto per il montaggio su superfici infiammabili.
Fixture ready for mounting on inflammable surfaces.



Apparecchio in classe II - Apparecchio nel quale la protezione contro la scossa elettrica non si basa unicamente sull'isolamento fondamentale, ma anche sulle misure supplementari di sicurezza costituite dal doppio isolamento o dall'isolamento rinforzato. Queste misure non comportano dispositivi per la messa a terra e non dipendono dalle condizioni d'installazione.

Class II appliance - appliance in which protection against electric shock is not only based on basic insulation, but also on additional safety measures, i.e. double insulation or reinforced insulation. These measures do not involve earthing devices and do not depend on the installation conditions.



Risparmio di energia.
Energy saving.



Grado di protezione - Stabilisce un sistema per la classificazione degli apparecchi elettrici in base al grado di protezione fornito dagli involucri degli stessi. I simboli utilizzati per indicare questo grado di protezione sono costituiti dalle lettere "IP" seguite da due cifre caratteristiche:







- la prima cifra indica la protezione contro la penetrazione dei corpi solidi e della polvere;
- la seconda cifra indica la protezione contro la penetrazione dei liquidi.

Protection level - This establishes a classification system for electric appliances based on the protection level supplied by their casing.

The symbols used to indicate the level of protection are the two letters, "IP" followed by two figures.
- The first figure indicates the protection against penetration by solid bodies and dust;
- The second figure indicates the protection against penetration by liquids.

Gradi di protezione IP - Protection degrees (IP)

1ª cifra protezione alla penetrazione di corpi solidi. 2ª cifra protezione contro la penetrazione d'acqua.
1st figure: protection against penetration by solid bodies. 2nd figure: protection against penetration by water.

0 Non Protetto. <i>No protection.</i>	0 Non Protetto. <i>No protection.</i>
1 Protetto da corpi solidi superiori a 50 mm. <i>Protected against solid matters (over 50 mm.).</i>	1 Protetto contro lo stillicidio. <i>Protected proof fixture.</i> 
2 Protetto da corpi solidi superiori a 12 mm. <i>Protected against solid matters (over 12 mm.).</i>	2 Protetto da cadute d'acqua, inclinazione di 15°. <i>Protected against water falling at 15° angle.</i>
3 Protetto da corpi solidi superiori a 2,5 mm. <i>Protected against solid matters (over 2,5 mm.).</i>	3 Protetto contro la pioggia. <i>Rain proof fixture.</i> 
4 Protetto da corpi solidi superiori a 1 mm. <i>Protected against solid matters (over 1 mm.).</i>	4 Protetto contro gli spruzzi. <i>Splash proof fixture.</i> 
5 Protetto contro la polvere. <i>Dust proof.</i> 	5 Protetto contro getti d'acqua. <i>Water jet proof.</i> 
6 Totalmente protetto contro la polvere. <i>Fully dust proof.</i> 	6 Protetto contro le ondate. <i>Wave proof.</i>

Nei nostri apparecchi, cablati secondo le norme relative alla classe I, la protezione contro le folgorazioni si basa, oltre che sull'isolamento del cavo di alimentazione, su una misura di sicurezza supplementare, costituita dal collegamento delle parti metalliche accessibili ad un conduttore di protezione (messa a terra), in modo che tali parti non possano in ogni caso divenire pericolose. Nel caso di apparecchi cablati in classe II, la protezione viene garantita da misure di sicurezza supplementari, costituite da un doppio isolamento delle parti in tensione. Queste misure non comportano l'adozione di dispositivi per la messa a terra.

I nostri apparecchi sono corredati da cavi ad alta resistenza termica e, in ottemperanza alle norme di sicurezza contro lo scoppio delle lampadine alogene lineare, da schermi protettivi in pyrex. Le laccature sono eseguite con polveri epossidiche essicate in forni ad alta temperatura, metodo che garantisce la massima resistenza ad urti ed abrasioni. Per facilitare le normali operazioni di pulizia dei vetri, consigliamo acqua tiepida. Fermo restando le caratteristiche basilari del prodotto, Morosini si riserva di apportare modifiche in ogni momento al solo scopo di miglioramento. I colori riprodotti nel presente catalogo possono, a causa della riproduzione su carta, differire dall'originale.

Our lighting fixtures are wired according to Class I specifications. Additional safety precaution against electric shocks are provided besides the insulation of the incoming feeder. All touchable metal components are connected to the grounding. Fixtures wired according to Class II are provided with double insulation, without grounding.

High thermic resistance wires are used and halogen bulbs are fitted with glass protector.

Epoxidic powders lacquering to guarantee perfect scratch resistance. For easier cleaning of glass diffusers some lukewarm water is recommended. While maintaining the basic characteristics of the product, Morosini reserves the right to make modifications at any time with the sole aim of improvement. Due to the reproduction on paper, the colours contained in this catalogue may be slightly different to the original colour tones.

Nos appareils ont le câblage selon les caractéristiques de la classe I. Outre l'isolation du câble il y a des systèmes de sûreté additionnels. Tous les composants sont connectés à la mise à terre.

Les appareils avec câblage selon la classe II ont une double isolation sans la mise à terre. Les appareils adoptent des câbles à haute résistance thermique, ampoules halogènes et écrans protectifs en pyrex. Les laquages sont faites en poudre époxy au but de garantir la parfaite résistance à coups et abrasion. Nous conseillons le nettoyage des verres avec de l'eau tiède.

Tout en respectant les caractéristiques de base du produit, Morosini se réserve le droit d'apporter des modifications en tous les moments rien que pour l'amélioration. Les couleurs indiquées au présent catalogue peuvent, à cause de la reproduction sur papier, différer de l'original.

Unsere Leuchten entsprechen der Klasse I. Zusätzlicher Schutz gegen Stromschlag kommt durch Isolierung des Kabels. Alle zugaengliche Metallteile sind mit der Erde verbunden. Die Leuchten die der Klasse II entsprechen, haben eine doppelte Isolierung, ohne Erde. Es werden hitzbestaendige Kabel montiert und die Halogenbirnen haben Schutzglas in Pyrex. Der Lack ist aus epoxydischem Pulver und schuetzt gegen Stoss und kratzer.

Die Glaeser mit lauwarmen Wasser. Unter Beibehaltung der wesentlichen Produktcharakteristiken behaelt sich die Morosini jederzeit Aenderungen zur Verbesserung der Produkte vor.

Die im Katalog wiedergegebenen Farben koennen aufgrund der Abbildung auf Papier vom Original abweichen.

En nuestros productos, cableados según las normas referentes a la clase I, la protección contra los rayos se basa, además de sobre el aislamiento del cable de alimentación, en una medida de seguridad suplementaria, constituida por la unión de las partes metálicas accesibles a un conductor de protección (con toma a tierra), de modo que dichas partes no puedan en ningún caso resultar peligrosas. En el caso de productos cableados en clase II, la protección se garantiza por medidas de seguridad suplementarias, constituidas por un doble aislamiento de las partes en tensión. Estas medidas no incluyen la adición de dispositivos para la toma a tierra. Nuestros aparatos van equipados con cables de alta resistencia térmica y, siguiendo las normas de seguridad para la explosión e las bombillas halógenas lineales, van también equipados con pantallas protectoras in pyrex.

El proceso de lacado incluye el secado de los polvos epoxidicos en hornos de alta temperatura, método que garantiza la máxima resistencia a los golpes y a las quemaduras.

Para facilitar las operaciones de limpieza normales del cristal, se aconseja el uso de agua templada.

Manteniendo las características base del producto, Morosini se reserva el derecho de realizar pequeños cambios con el fin de mejorar la calidad del producto. Los colores indicados en el presente catálogo pueden ser distintos del original a causa de la reproducción sobre papel.

Associato
Associate

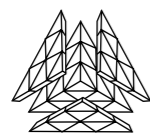

assoLuce

Associazione nazionale
delle imprese degli apparecchi
di illuminazione



**UNINDUSTRIA
VENEZIA**

Thanks to:

CERAMGRES - Carbonera (TV)

BENETAZZO - Tessera (VE)

ARKIUTTI - Roncade (TV)



MOROSINI®
luce & design

Morosini
Divisione Luci Italiane srl
via delle Industrie, 70
30020 Marcon (VE) - Italy
t. +39 041 5952772
f. +39 041 5956175
info@morosinisrl.com
www.morosinisrl.com